

Systems Reference Library

IBM System/360 Basic Operating System Control Programs and Assembler Operating Guide

Program Numbers

- Basic Control Program 360B-CL-302
- Consecutive Processing Macros 360B-IO-303
- Indexed Sequential File Management
System (ISFMS) Macros 360B-IO-304
- Direct Access Method (DAM)
Macros 360B-IO-305
- Assembler 360B-AS-309

This publication is divided into three parts:

Part 1 explains briefly the functions of the programs in the Basic Operating System.

Part 2 gives operating procedures for the IBM System/360 Basic Operating System Control and Service Programs and Assembler. Procedures for generating a resident system, and obtaining and using system backup are included, as well as a section on system/operator communication.

Part 3 presents the formats of Job Control, Linkage Editor, and library program control cards.

A series of appendices include reference charts for System/360 code conversion and a table of IBM-supplied program and macro names.

For information about the operation of the System/360, see IBM System/360 Model 30 Operator's Guide, Form A24-3373. Operating guides for other programs available in the System/360 Basic Operating System are in separate publications. For these and other related publications, see IBM System/360 Bibliography, Form A22-6822. All Basic Operating System Operator Messages are cataloged in IBM System/360 Basic Operating System, Operator Messages, Form C24-5024.

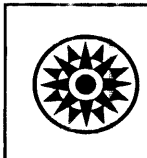

PREFACE

Part 1 of this publication presents the concepts of the IBM System/360 Basic Operating System. The functions provided are explained briefly. Persons with a knowledge of basic operating system concepts may want to skip this part and refer only to the sections on operating procedures and error messages.

Part 2 has a section on general operating procedures. These include procedures for starting system operation (the IPL procedure), starting a job, terminating a job, and restarting a checkpointed job. There is an explanation of the types of communication between the system and the operator. Individual sections give the operating procedures for the Assembler and system control and service programs. Procedures are

also given for generating a system, obtaining system backup, and recreating a system from backup.

Part 3 contains the formats of job control cards, Linkage Editor input cards, and program control cards (used by library programs).

Appendices A, B, C, and D are reference charts for System/360 code conversion. Appendix E contains the names of IBM supplied programs and macros in the System/360 Basic Operating System.

Although this BOS Operating Guide is intended primarily for operators, others may find it useful in planning and/or programming jobs.

SIMPLIFIED TERMINOLOGY

The titles of some IBM programming systems have been simplified as shown below:

former: IBM System/360 Basic Operating System (8K Disk)
new: IBM System/360 Basic Operating System

former: IBM System/360 Basic Operating System (16K Tape)
new: IBM System/360 Tape Operating System

former: IBM System/360 Basic Operating System (16K Disk)
new: IBM System/360 Disk Operating System

Major Revision, May 1966

This edition, Form C24-3450-2, is a major revision of, and obsoletes, Form C24-3450-1. Changes are designated in three ways:

1. A vertical line appears at the left of affected text where only a part of the page has been changed.
2. A dot (●) appears at the left of the page number where the complete page should be reviewed.
3. A dot (●) appears at the left of the title of each figure that has been changed.

The affected pages are: Title Page, Preface, Contents, 5, 18, 28, 34, 38, 39, 42-44, 48, 52-56, 63, 76-78, 84, 101, 102, 104 and the Index.

Part 4: Error Messages has been deleted.

Copies of this and other IBM publications can be obtained through IBM Branch Offices. A form has been provided at the back of this publication for readers' comments. If the form has been detached, comments may be directed to: IBM Programming Publications, Endicott, New York 13760

INTRODUCTION	5
PART 1. CONCEPTS	6
Language Translation Functions	6
Installation Service Functions	7
System Control Functions	8
System Service Functions	11
Organization of the System Pack	12
Principles of System Operation	13
PART 2. OPERATING PROCEDURES	15
General Procedures	15
System/Operator Communication	26
Assembler	33
Library Programs	46
AORGZ--Reallocate Library Limits Program	50
CORGZ--Copy System Program	51
CSERV--Core Image Library Service Program	52
DSERV--Directory Service Program	54
LORGZ--Condense Library Program	58
MMAINT--Macro Library Maintenance Program	59
MSERV--Macro Library Service Program	60
PSERV--PUB Table Service Program	62
RMAINT--Relocatable Library Maintenance Program	64
RSERV--Relocatable Library Service Program	65
SYSCMA--Core Image Library Maintenance Program	67
System Generation	68
Basic Operating System Backup	72
PART 3. CARD FORMATS	76
Job Control Cards	76
Linkage Editor Input Cards	81
Librarian Program Control Cards	85
APPENDIX A: EXTENDED BINARY CODED DECIMAL INTERCHANGE CODE (EBCDIC)	88
APPENDIX B: BINARY TO DECIMAL CONVERSION	91
APPENDIX C: BINARY TO HEXADECIMAL CONVERSION	92
APPENDIX D: DECIMAL/HEXADECIMAL CONVERSION	95
APPENDIX E: NAMES OF PROGRAMS AND MACROS	101
INDEX	106

IBM SYSTEM/360 BASIC OPERATING SYSTEM
CONTROL PROGRAMS AND ASSEMBLER OPERATING GUIDE

The Basic Operating System/360 consists of language translation system control, and service programs that provide for efficient use of 8K (and larger) System/360 disk-resident installations.

An operating system is a set of programs that, with the aid of an operator, permits continuous operation of a system. One characteristic of an operating system is that all its programs can be immediately available for execution, but they are not all in

main storage at all times. Thus, there is constant access to an external storage medium, called the residence of the system or the system residence volume. The system residence volume used in the Basic Operating System/360 is a disk pack called system disk pack mounted on an IBM 2311 Disk Storage Drive. The system disk pack contains the programs and routines that make up the operating system. It is on-line for the execution of all programs, both those supplied by IBM and those written by the user.

PART 1: CONCEPTS

The overall objective of any data processing installation is to convert quantities of source data into reports or other meaningful form that management can use in the successful operation of its business. Converting the source data to usable form generally requires a series of steps or operations. The performance of each operation is based on the principle of obtaining input data, and producing desired output data. The output may be the end result of the overall objective, or it may be the input to a subsequent operation that is yet to be performed.

The operations required to process the data can be performed on the System/360 by use of a series of programs. A program is a set of instructions to tell the system what functions to perform, such as reading or writing data, adding or moving data, controlling the system, etc. Programs are either written by the user or supplied by IBM.

The user writes problem programs to perform whatever processing of data he requires to obtain the desired output. For example, in a payroll application his problem program may process employee hours and rates to produce pay checks, year-to-date earnings, withholding tax reports, work load analyses, etc.

Programming systems supplied by IBM aid the user by providing him with prewritten and pretested programs for many of the generalized functions that must be performed in conjunction with his data processing (for example, programs to sort records). Thus, the use of these programs reduces the number of programs that the user himself must write and test.

The programs in the Basic Operating System can be categorized by the functions they perform:

- Translate the symbolic language of a user-written problem program so that it is expressed in machine language, and therefore, acceptable to the System/360.
- Provide installation service functions for the user, such as: sorting his records; transferring a file of records from one storage medium to another (for example, a card file to a disk file); testing a program for errors.
- Provide system control functions for the processing or service programs, such as loading a program from disk, cards, or

tape into the System/360 main storage for execution.

- Provide system service functions for the system disk pack, such as adding programs to the system.

LANGUAGE TRANSLATION FUNCTIONS

To provide the System/360 with instructions to process his data, the user writes a problem program that includes information about the sources of input data, processing to be performed with the data, and desired output data. This program is called a source program, or source module, and it is generally written in a symbolic language that is easily understood by the programmer.

Symbolic languages consist of sets of specified mnemonic codes and rules for expressing various types of instructions or specifications. They permit the use of user-selected names (or symbols) for reference back and forth between instructions in the program. These symbols represent locations, or addresses, where the instructions will be entered in main storage when the program is loaded into the machine.

Although symbolic languages are available to simplify the programmer's work, they cannot be understood by the machine. They must be translated to a language that is acceptable to the machine. The System/360 can then interpret and carry out (execute) the programmer's instructions. The translation from symbolic language to machine language can be performed by either of two language processing programs in the 8K disk basic operating system: the Assembler or the Report Program Generator (RPG). Each of these programs is a set of instructions in machine language that has been written specifically to translate user's symbolic-language programs to machine-language programs.

ASSEMBLING A PROGRAM

One of the symbolic languages in which the user writes his source program is known as assembler language, and the process of translating assembler language to machine language is known as assembling, or performing an assembly.

To permit the assembly of a source program, the user-written instructions are first punched into a deck of cards, usually one card for each instruction. The instruc-

tions are written and punched in a format that is recognized by the assembler program. The deck of cards is then read into the System/360 and processed by the assembler. As the symbolic source language is translated, each symbolic instruction is replaced by one (or several) machine-language instructions. At this time, storage addresses, which can be changed (relocated) later if desired, are assigned to the instructions.

The output from the assembly is an object module that is punched in cards or written on disk or tape. An object module is an executable object program or a portion of an object program that will be combined with other modules to form a complete object program for execution. If the assembly output is in cards, each output card contains several instructions. This is known as a condensed card deck. Any time after the assembly, the object program can be read into the System/360, processed by the linkage editor (see System-Service Functions: Linkage Editor), and then executed to perform the instructions as originally written by the programmer.

Associated with the assembler are pre-written routines to control input/output control system (IOCS) functions, such as reading from an input file or writing on an output device. To utilize the IOCS routines, the programmer can write a single instruction (such as GET to obtain a record), and from this the appropriate series of input/output instructions is included in his program.

A single instruction (such as GET) that results in several instructions is called a macro instruction. The series of instructions, which replaces the single instruction when the program is assembled, is called a macro definition (frequently abbreviated to macro). Thus, the macro routine becomes an integral part of the object program for execution. Some of the functions provided by the IOCS routines are:

- Checking and writing disk or tape labels. Tape files can be processed with or without labels. Disk files must have labels. The advantages of label usage include file identification, protection, and auditing provisions (dating of files, etc). Two types of labels are provided: volume labels and file labels. A volume label identifies the volume (disk pack or tape reel) on which it is written. File labels identify each individual file of records (a logical file, such as a payroll file) on the pack or reel.

For a logical file on disk, the file label also indicates the extent of the file. Extent specifies the addresses of the first and last records of the file in

a continuous area of the disk pack. If a logical file is stored in two or more areas of the pack, two or more extents are included in the label. For a logical file on tape, two file labels are used: A header label preceding the file, and a trailer label following the file.

- Deblocking records. When a block of several records is read into main storage from an input device (such as a disk drive or magnetic tape unit), one record at a time within the block is made available for processing.
- Blocking records. Records can be grouped so that several records are transferred to an output device at one time.
- Detecting and handling end-of-file conditions.

REPORT PROGRAM GENERATOR (RPG)

The RPG language is a problem-oriented language in which the programmer uses a set of specification sheets to define his files, state the calculations to be performed, and define the desired format of the output reports. This information is punched into cards and represents the source program, which is processed by the RPG program to produce an object program.

INSTALLATION SERVICE FUNCTIONS

The purpose of and reasons for installation service functions are discussed briefly in the following paragraphs. The functions discussed are performed by these programs:

Sort/Merge
Utilities
Autotest

SORTING AND MERGING

Before a user can actually execute a particular program to process his data, he may find that he must arrange his data records in an order, or sequence, that suits the output desired from the operation. Sort/Merge programs accomplish this type of function. These are generalized programs, and, therefore, the same program can be used for any sorting arrangement. The user merely specifies the control information (job number, part number, etc.) by which the records are to be sorted. These programs also permit separate sets of records to be combined (merged) into one set that is in order by specified control information. Input records for a sort/merge operation may be read from disk, tape, or cards. Output records may be written on disk or tape.

TRANSFERRING RECORDS

Another function that may be required for the user's data records is the transfer of those records from one storage medium to another. This may be required either before or after a particular object program is executed to process data. For example, it may be necessary to transfer records from cards to disk, from one disk pack to another, etc. Programs that are known as Utility Programs can be used to perform these transfer operations.

Similar to the sort/merge programs, the utility programs are generalized programs. They can be applied to any file of records. The user specifies the type of storage medium and pertinent facts about the records themselves, such as the size of the records, how many records in a block, etc.

TESTING A PROGRAM

After a source program has been successfully assembled, the resultant object program must be tested (debugged) before it is used to process actual data. In any job, every unique situation that can occur should be tested. For this, the programmer generally prepares a deck of test data that simulates the actual data, and processes it using his newly created program. Whenever some error is detected during this debugging operation, he must analyze this particular situation and correct his program. In some cases, this operation requires considerable analysis and the programmer must know what is in main storage, in the registers, etc., at different points in the program. In some cases he can correct the object program by patching it, but in other cases he must adjust the source program and reassemble.

A program called Autotest aids in the debugging and patching of programs. Autotest performs such functions as providing a listing of the contents of core storage at specified points in the program, incorporating patches in the program, etc.

SYSTEM CONTROL FUNCTIONS

System control functions are concerned with the over-all control of programming operations in the System/360. They are applicable either before or during the execution of programs supplied by IBM (such as assembler) or written by the user. The programs that are considered system control programs are:

- Initial Program Loading (IPL).
- Supervisor.
- Job Control.

INITIAL PROGRAM LOADING (IPL)

An IPL function is required to initiate operation when the System/360 is first started, as at the beginning of the day. An IPL routine (program) is located on the system disk pack, and it is loaded into main storage by a procedure commonly known as the IPL procedure. The IPL routine clears main storage and registers, and it loads the Supervisor from the system disk pack into the lower part of main storage. IPL then calls the job control program to perform setup functions for the first program to be executed. The steps that are to be taken in an IPL Procedure are given under Operating Procedures: Starting System Operation.

SUPERVISOR

The supervisor, which resides in main storage, contains routines to load programs and to handle interruptions from the operator or the system and input/output requests from the program.

JOB CONTROL

This program provides job-to-job transition within the basic operating system. When a job (program) reaches the normal end-of-job, the supervisor fetches (retrieves and loads) the job control program. Job control then performs setup functions for the next job to be executed. The functions provided by job control are:

1. Indicate the name of the job to be executed next.
2. Assign actual input/output devices (addresses) to the symbolic units (SYSRDR, SYSLST, etc.) used by the problem program. See I/O Device Assignment.
3. Place today's date in the communication region of the supervisor. The communication region is used for giving information to, or receiving information from, the supervisor.
4. Set (ON or OFF) the User Program Switch Indicators in the communication region of the supervisor.
5. Edit and store label information for later use by the disk or tape label routines.
6. Store machine-configuration information (storage capacity and availability of special features) in the communication region of the supervisor.
7. Allow restarting of a program that was previously terminated before the nor-

<u>Operation</u>	<u>Meaning</u>	<u>Function/Comments</u>
JOB	Job Name	Required. Must be the first card in a group. Provides the name of the program to be executed.
ASSGN	Assignment	Assigns a specific I/O unit (device address and device type) to a symbolic unit (such as SYSRDR or SYS000).
FILES	Tape File	Positions a tape reel after a specific tape mark. It can be used for restarting checkpointed programs.
VOL	Volume Information	Supplies volume information for checking/writing labels. Information is stored in the volume area of system residence.
TPLAB	Tape Label Information	Supplies file information for checking/writing tape labels. Information is stored in the volume area (label control card area) of the system pack.
DLAB	Disk Label Information	Supplies file information for checking/writing disk labels. Information is stored in the volume area of system residence.
XTENT	Extent of Disk File	Defines each area (or the extent) of a disk file (information such as file limits).
DATE	Today's Date	Places today's date in the communication region of the Supervisor. It must be included for the first job after an IPL.
UPSI	User Program Switch Indicators	Sets user's program switches (on or off) in the communication region of the supervisor.
CONFG	System/360 Configuration	Changes the machine configuration specified by the supervisor. (Only programs that make use of the configuration information are affected.)
PAUSE	Pause	Allows the operator setup time before a job is executed. (The machine is placed in the wait state.)
LOG	Log (print)	Allows Job-Control cards to be printed on a 1052 Printer-Keyboard or a printer.
NOLOG	Stop Logging	Discontinues printing of Job-Control cards (started by LOG).
ATEOF	Autotest End of File	Indicates the end of Autotest job input. (Control is given to the Autotest program.)
RSTRT	Restart	Permits restarting an interrupted job. Identifies the source of checkpoint records (disk or tape) and, if on tape, identifies a particular group of checkpoint records to be used. Indicates that the restart phase of Job Control is to be executed.
EXEC	Execute Job	Required. Must be the last card in a group. Causes the requested program (specified by the JOB card) to be loaded and executed. It indicates to Job Control whether or not the Linkage Editor is needed to edit the program before execution.

Figure 1. Job Control Cards

mal end-of-job was reached (see Restarting a Checkpointed Job).

8. Print (log) job-control cards.
9. Initiate execution of the next job.
10. Allow processing to be suspended before the job is executed, so that the operator can perform any preparatory operations.

To perform the functions required for a particular program, the job-control program reads information from a series of two or more job-control cards that have been prepared by the user. The cards that job control reads are listed in Figure 1. This list shows the operation to be performed, its meaning, and briefly its use. The detailed specifications for punching each card are described under Card Formats: Job Control Cards.

A JOB card and an EXEC card are always required. The other cards that are required depend on the operations included in the problem program. The specific job-control requirements for IBM programs on the system disk pack are given in the operating procedures for each program.

Job-control cards must be read from the input device that is assigned to SYSRDR (see I/O Device Assignment).

I/O Device Assignment

All source programs refer to I/O devices by symbolic units, rather than by actual device addresses. The job-control program associates (by ASSGN control cards) an actual device address with each symbolic unit. That is, job control assigns a device address to a symbolic unit.

The ability to refer to an I/O device by a symbolic unit, rather than a physical address, provides advantages to both programmers and operators. The symbolic unit for a device is chosen by the programmer. He can write a program that depends only on the type of device and not on the actual device address. At execution time the operator determines the actual physical device to be assigned to a given symbolic unit, and he communicates this to job control by a job-control card (ASSGN).

A fixed set of symbolic units is used to refer to devices:

<u>Symbolic Unit</u>	<u>Device Type</u>
SYSRES	Disk (2311)
SYSRDR	Control-card reader (1442, 2501, 2520, 2540)
SYSLST	Listing device (1403, 1404, 1443)
SYSIPT	Program and data input device (a disk drive, a card reader, or a tape unit)
SYSOPT	Output device (a disk drive, a card punch, a tape unit, or a display unit)
SYSLOG	Control-card logging device. If a 1052 Printer-Keyboard is available, it should be assigned to SYSLOG.
SYS000-SYS254	Other symbolic units in the system.

An example of the use of these symbolic units is:

1. The programmer refers to a tape unit as SYS000.
2. In the operating instructions he writes: "Mount a scratch tape on SYS000".
3. The operator selects an available tape unit, mounts a scratch tape on that unit, and submits a control card (ASSGN) to job control. This card contains symbolic unit SYS000, the device address of the tape unit he selected, and the device type (code for tape unit).
4. Each time the program requests an input/output operation on SYS000, the tape unit selected by the operator is utilized.

Restarting from Checkpoint Records

The job control program includes a function (RSTRT) that provides for restarting jobs that have been terminated and for which checkpoint records have been written. These records contain the status of the job and the system at the time the records are written.

The checkpoint records may be written on either a disk pack or a tape reel. When they are written on disk, one set of checkpoint records is available for restarting the job, because each set supersedes the previous set. All checkpoint records are written in the same area of a disk pack. When checkpoint records are written on tape,

however, all sets written during program execution are available on the tape reel. The user must specify (to the job-control program) which set of checkpoint records is to be used to set up the system for restarting the job.

The restart routines identify the checkpoint records, and, from them, restore the System/360 registers, the communication region of the supervisor, and the problem program area. It also repositions the data input and/or output tapes (if any) at the proper position to continue where processing left off.

SYSTEM SERVICE FUNCTIONS

These functions are concerned with the generation of the system disk pack, with the maintenance of the pack (addition or deletion of programs or routines), and with service of the pack (punching or printing out the contents of portions of the pack). The system service functions are grouped under the headings:

Librarian
Linkage Editor
Load System Program

LIBRARIAN

The librarian consists of a group of separate programs that are used to update and reorganize the libraries on the system disk pack, and to provide punched or printed output of the contents of the libraries. The identification and functions of each program are given under Operating Procedures: Library Programs.

A library is a collection of programs or routines in a specific section of the system disk pack. Each library has an index, or directory, of the permanently stored programs, so that each program is readily accessible at any time. Whenever a program is permanently added to a library, the directory is adjusted accordingly. This operation is known as cataloging a program into a library.

The Basic Operating System (8K Disk) provides three different libraries on the system disk pack. The particular library in which an individual program or routine is stored depends on the form of the program or routine. The libraries and their contents are:

- **Macro Library:** Contains macro definitions (see Assembling a Program) supplied by IBM or written by the user.

- **Core Image Library:** Contains programs, or program phases (a section of a program that is executed by itself), that can be loaded by the system supervisor for immediate execution. That is, all relocations (changes of addresses) have been resolved previously, and the programs contain machine-language addresses (called absolute addresses). All programs to be executed must be loaded into main storage from the core image library.

The system programs in the core image library include language-processing programs, system-control programs, librarian programs, and installation-service programs. Programs, or program phases, written by the user may also be stored permanently in the core image library. In addition, the core image library provides an area for the temporary storage of a program. Temporary storage means that the core image directory is not affected and that the program is destroyed by the next program that is stored. The program that is stored is immediately loaded into main storage and executed.

- **Relocatable Library:** Contains object programs, or object modules, whose addresses will be changed (relocated) before the programs are executed. When system operation requires the execution of a particular object module, that module is combined with others (if required), its addresses are relocated, and it is transferred to the core image library (see Linkage Editor). Then, the object program is loaded into main storage for execution.

LINKAGE EDITOR

The object program, or object module, resulting from an assembly or compilation is either written on disk in the relocatable library, punched into cards, or written on tape. Before the object program (or modules) can be executed, however, its format must be changed and it must be placed in the core-image library. These functions are known as editing, and they are performed by the Linkage Editor program. Thus, use of the Linkage Editor is always required as an intermediate function between the assembly (or compilation) and execution of a program.

The Linkage Editor also performs any relocations that are needed, and combines modules into one executable program, if required. The object program (or module) is in relocatable form. This means that the addresses that have been assigned (during assembly) to the instructions are temporary and may have to be changed (relocated) before the program can be executed.

If two or more modules are to be combined, relocation is generally required to prevent one module from destroying the other when they are loaded into main storage for execution.

The Linkage Editor program is not run as a distinct program by itself, but it is used with another program. It is called (retrieved from the system disk pack) into storage for execution by the job control program when an object program is to be executed (link-and-execute operation). It is called by the assembler (or RPG) when a program is to be compiled and executed immediately (assemble-and-execute operation). Either of these operations causes the object program to be stored temporarily in the core image library. A program may be stored permanently in the core image library, by use of the core image library maintenance program (SYSCMA). In this case the SYSCMA program calls the Linkage Editor.

Load System Program

This program is used to create a system disk pack from a card deck that contains system programs and routines. Its primary use is the creation of a pack from a backup deck (see Operating Procedures: Basic Operating System Backup).

The load system program (LDSYS) operates as an independent system. It is provided by IBM in a deck of cards. It is not on the system disk pack. The deck contains its own IPL routine, supervisor, and job control program preceding the LDSYS program.

ORGANIZATION OF THE SYSTEM PACK

The disk resident system occupies the first section of the system pack, starting with track zero on cylinder zero. The contents of the first six tracks, the core image directory, the core image library, and the label control card area exist on all system packs. The system pack is organized as follows:

<u>Cylinder</u>	<u>Track</u>	<u>Contents</u>
00	00	<u>IPL</u> : Used to retrieve the IPL program when the operator presses the load key. The volume label is also on this track.
00	01	<u>System Directory</u> : Master directory for the resident system. It consists of a number of records describing each library and directory, its lo-

cation, and present status. Records included describe the following: core image directory, core image library, macro directory, macro library, relocatable directory, relocatable library, checkpoint area, label control card area, and the IPL initialization program.

00	02-03	<u>Librarian Area</u> : Area reserved for use as a work area by librarian programs.
00	04	<u>Transient Directory</u> : Directory describing the location of frequently used system-control routines in the core image library. This directory is maintained to minimize retrieval time.
00	05	<u>Phase Directory</u> : Directory describing phases within the current job. This directory is constructed by Job Control for each job to minimize retrieval of phases within a job.
00	06-xx	<u>Core Image Directory</u> : Contains names and locations of all phases within the core image library.

Core Image Library: Contains program phases in core image format (for example, the Supervisor, Job Control, Linkage Editor, SYSCMAINT, Assembler).

Macro Directory: Contains names and locations of macros within the macro library.

Macro Library: Contains IBM-supplied and user-defined macros.

Relocatable Program Directory: Contains names and locations of modules within the relocatable program library.

Relocatable Program Library: Contains modules in relocatable form.

Label Control Card Area:
 Job Control stores control card information in this area for use (during program execution) by the disk and tape label processing routines (OPEN, CLOSE, etc.).

Checkpoint Area: Used for storing checkpoint records taken during execution of a problem program.

In addition to the area occupied by system residence, a system pack must have a volume table of contents (VTOC). The VTOC contains file labels for each file on that disk pack. It can be anywhere outside of the area used for system residence. A system pack may also have areas set aside for work areas and data file areas.

PRINCIPLES OF SYSTEM OPERATION

The principles of system operation are:

- The Initial Program Loader is used to begin system operations (by loading a supervisor and job control program into storage).
- The Supervisor resides in main storage and performs its functions during execution of problem programs.
- The Job Control program prepares jobs to be run by analyzing control cards and then performing requested functions between job executions.
- A problem program is executed after being edited by the Linkage Editor or after being fetched directly from the core image library.

An illustration of these principles follows. (The discussion assumes the existence of a complete basic operating system. To get the system started, only 1 and 2 are performed; 3 and 4 are parts of a loop that continues until there are no more jobs to be run.) See Figure 2.

1. The operator places the system pack on an IBM 2311 Disk Storage Drive and selects the address of that drive in the load-unit switches on the console (system control panel). Pressing the load key causes the IPL routine to be read from the system pack.
- 2a. The IPL routine loads the Supervisor from the core image library into the lower part of main storage. Before turning control over to the Supervisor,

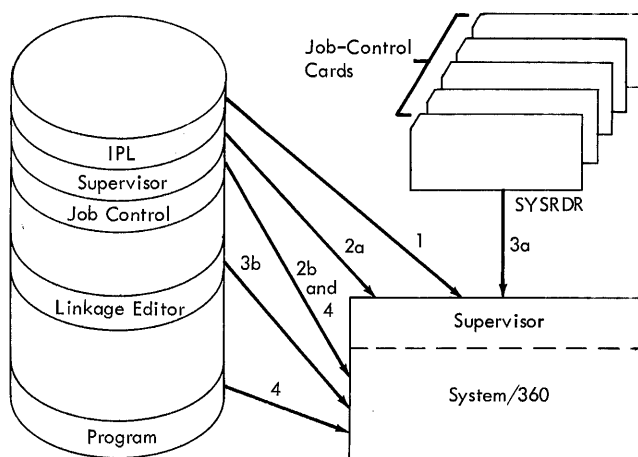

Figure 2. Principles of System Operation

certain other initializing functions are performed. Main storage and the general registers not used by IPL are cleared to zeros. The address of the resident system disk drive is stored for use by the Supervisor.

- 2b. Pressing the interrupt key causes control to be given to the Supervisor, which uses the system loader routine to call Job Control. (Operation of the system loader routine is described under 4.)
- 3a. Job Control reads the job control cards that define the job to be run. These cards are placed in the system card reader (SYSRDR). Information from these cards is used to:
 - Assign actual I/O device addresses to the symbolic units used by the program to be executed.
 - Store tape and disk label information in the label control card area of the system disk pack for subsequent use by the routines that process the labels.
 - Place information in the communication region within the Supervisor, including today's date, machine configuration, and user program switches.
- 3b. If the Linkage Editor is required, it is fetched from the core image library. The Linkage Editor reads program phases from the relocatable library and/or the system input unit (SYSIPT) and edits the program into the core image library.

The final function performed by Job Control (regardless of whether

the Linkage Editor is required) is to construct a phase directory of the program to be run and write this on the system pack. The system loader routine uses this directory to locate successive phases of the problem program in the core image library.

4. The system loader routine of the Supervisor loads the first phase of the problem program in response to a request by Job Control. During the running of the job, control alternates between the problem program and the Supervisor.

The problem program requests the system loader routine to load successive program phases through the FETCH macro.

An end-of-job macro-instruction (EOJ) in the problem program causes Job Control to be loaded into main storage. Job Control then reads the control cards for the next job (3a).

The control cards for the last job to be run are followed by a PAUSE card that causes processing to be suspended.

GENERAL PROCEDURES

STARTING SYSTEM OPERATION

Figure 3 illustrates the procedure for starting system operation. Generally,

this may also be considered the IPL procedure. In this figure (see Steps 5 and 6) and throughout Parts II and IV of this guide, an addressable position of main storage is referred to as a byte. A byte is a sequence of binary digits that can be operated upon as a unit.

STEP	PROCEDURE	COMMENTS
1	Press POWER ON.	
2	Mount the system pack on a 2311 disk drive. Ready this device.	
3	Place job-control cards in the control card reader. Ready this device.	A DATE card must be included with the job-control cards for the first job. A LOG card must be included if job-control cards are to be logged.
4	Dial the load-unit switches on the system control panel to the address (channel and unit) of the 2311.	
5	Press LOAD.	IPL and the Supervisor are loaded into main storage. The channel and unit address dialed in the load-unit switches is stored (in a device table) for use by the Supervisor. The system enters the wait state. (Bytes 0, 1, and 2 each have a hexadecimal value of FF.)
6	If the device address for SYSRDR is to be assigned: Press STOP Observe the WAIT light (must be on) Enter the new address in bytes 0, 1, and 2 Press START. Otherwise, omit this step.	This step is used to make, or change, an assignment for SYSRDR. <u>Byte 0--Channel Number</u> 00 for Multiplexor Channel 01 for Selector Channel 1 02 for Selector Channel 2 <u>Byte 1--Unit Number</u> 00 to FF <u>Byte 2--Device Type</u> 04 for 1442 Card Reader 08 for 2540 Card Reader 14 for 2501 Card Reader 16 for 2520 Card Reader
7	Press INTERRUPT.	Job Control is loaded and control is given to it.

Figure 3. Starting System Operation

STARTING A JOB

Figure 4 illustrates the general procedure used when setting up a job for execution.

It is assumed that processing has been suspended by use of a PAUSE card.

STEP	PROCEDURE	COMMENTS
1	Ready input/output units.	Load paper in the printer; mount tape reels, disk packs; place blank cards into the card punch; etc.
2	Place job control cards for this job in the control-card reader (SYSRDR).	The first card is always JOB, and the last card is always EXEC for any job.
3	If the program is in cards, place it in the card reader which is SYSIPT. If the program is in card-image form on tape, mount that tape reel. Otherwise, omit this step.	The job-control cards for this job must assign that tape unit to SYSIPT.
4	Place input data in the appropriate input device, if required.	
5	Reply to the PAUSE card message (1703A)	

Figure 4. Starting A Job

Symbolic Unit	Function and Device
SYSLOG	Required if: <ol style="list-style-type: none"> 1. the Supervisor MSG (message) routine is to print messages. It must be a 1052 Printer-Keyboard. 2. the job-control LOG function is specified. It can be an IBM 1403, 1404 (continuous forms only), or 1443 Printer, or an IBM 1052 Printer-Keyboard.
SYSLST	Required if: <ol style="list-style-type: none"> 1. the Linkage Editor is to print diagnostic information. 2. the MAP function of the Linkage Editor ACTION card is used. 3. certain library programs (AORGZ, LORGZ, MMAINT, RMAINT, SYSCMA) are to print status reports and/or additional diagnostic information. IBM 1403, 1404 (continuous forms only), or 1443 Printer
SYSIPT	Input device for program modules. Required when input is in cards or in card-image form on tape. IBM 1442, 2520, or 2540 Card Read Punch, IBM 2501 Card Reader, or an IBM 2400-series Magnetic Tape Unit (9-track, or 7-track with the data conversion feature). It must be positioned to the first data record. May be the same device as SYSRDR.
SYSRDR	Required input device for job-control cards. IBM 1442, 2520, or 2540 Card Read Punch or an IBM 2501 Card Reader.

Figure 5. Symbolic Units for Device Assignments

Symbolic Units For Device Assignments

Figure 5 lists the symbolic units that are frequently referred to by system programs. It gives the function and possible device assignments for each unit.

Operator Instructions to Job Control

The operator can use the PAUSE, LOG, and NOLOG job-control cards to give certain instructions to Job Control. These cards can be placed anywhere (in any order) in the job-control input stream.

The PAUSE card causes a message to be issued. All processing is suspended until a reply is given. (The system is in the

wait state.) The PAUSE card should be used when the operator needs setup time between jobs. (Usually when a program reaches end-of-job there is no interruption of processing.) If a PAUSE card is encountered before a JOB card, the pause is effective immediately. If a PAUSE card is encountered between the JOB and EXEC cards for a particular job, the pause is effective just prior to calling in the program for execution.

The LOG card causes Job Control to log (print) all job control cards that follow it. Logging is continued until a NOLOG card is encountered or an IPL procedure is initiated. (For control cards to be logged, a device must be assigned to SYSLOG; if it is not, no logging can be done.)

Linkage Editor Printed Output

The Linkage Editor provides two kinds of printed output on SYSLST, unless ACTION NOMAP is specified.

1. A printout (map) of information concerning the output from the Linkage Editor run (Figure 6). This information is printed in sequence by input module (input to the Linkage Editor). Therefore, an ACTION NOMAP card must be included for any module for which no printout is desired. If a device is not assigned to SYSLST, no map is printed.

2. Diagnostic information, in addition to any error messages. The format of the diagnostic information is:

ERROR nn (EBCDIC printout of the card in error)

Where nn is a two-digit number indicating the type of error. nn is identical to the third and fourth characters of the error messages beginning with 2L. Columns 6-8 of the card are printed in hexadecimal when the card is not a control card.

10/09/65	PHASE	LOCORE	HICORE	XFR-AD	DSK-AD	ESD TYPE	LABEL	LOADED	REL-FR
	DPLE11	001000	001647	001000	OF 2 3	CSECT ENTRY	PHAA SWITCH	001000 001068	001000
						CSECT	PHAB	0010A0	0010A0
						CSECT	PHAC	001140	001140
						CSECT	PHAD	0011E0	0011E0
						CSECT	PHAE	001280	001280
						CSECT	PHAF	001320	001320
						CSECT	PHAG	0013C0	0013C0
						CSECT	PHAH	001460	001460
						CSECT	PHAI	001500	001500
						CSECT	PHAJ	0015A0	0015A0

Annotations:

- Phase Name: DPLE11
- Beginning: 001000
- Ending: 001647
- Entry: 001000
- Cylinder: OF 2 3
- Head: 2
- Record: 3
- Address in Main Storage: 001068
- Control Section Names: PHAA through PHAJ

● Figure 6. Linkage Editor Printed Output

If an error is detected during the linkage editing of a system program (module name beginning with SYS), diagnostic information is printed to indicate this condition:

ABORT - ERROR ON SYS PROGRAM

If LOG is specified and SYSLOG is assigned, this diagnostic information is printed on the device assigned to SYSLOG rather than the device assigned to SYSLST. Printing on SYSLOG is not affected by the ACTION NOMAP card.

Examples

Four examples follow of the card input and the input/output units used for executing jobs under certain conditions. Figure 7 shows the setup for a program (PROGA) that is in the core image library and can be called into storage and executed immediately. Figure 8 illustrates the setup for a program that is in the relocatable library. The Linkage Editor must perform certain functions before the program (PROGB) can be executed. This process is called link-and-execute. Figure 9 shows typical input when a program (PROGC) is read from SYSIPT. This is another example of link-and-execute. Figure 10 illustrates possible input for several programs which are run as stacked jobs.

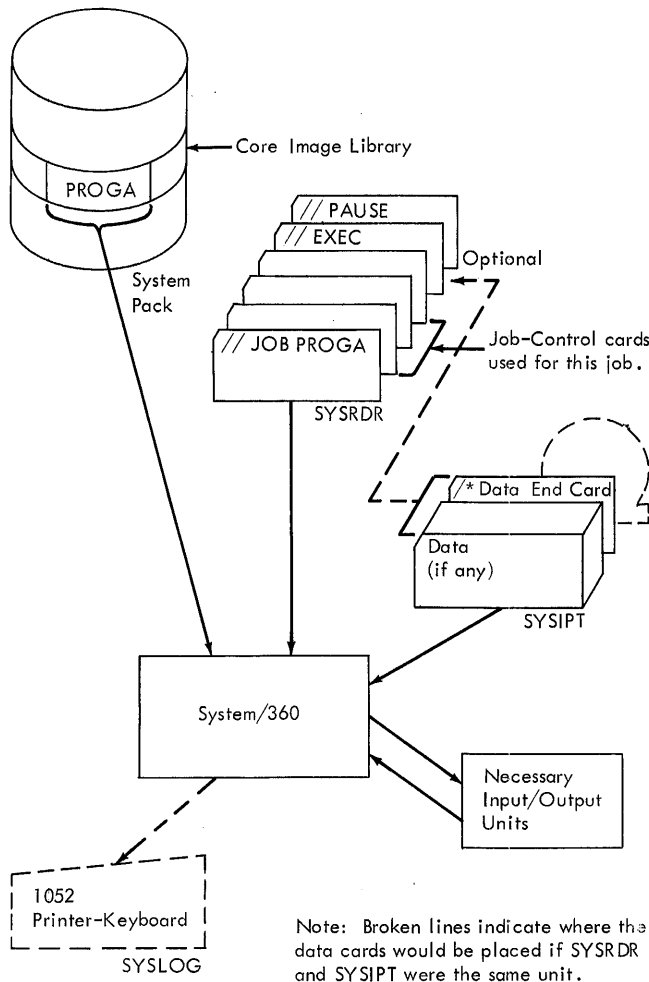

Figure 7. Example 1: Program is in the Core Image Library (Part 1 of 2)

Card Arrangement	Comments
<pre>// JOB program name } Job control cards } used for this job // EXEC Data, if any Data End Card, if needed</pre>	

Figure 7. Example 1: Program is in the Core Image Library (Part 2 of 2)

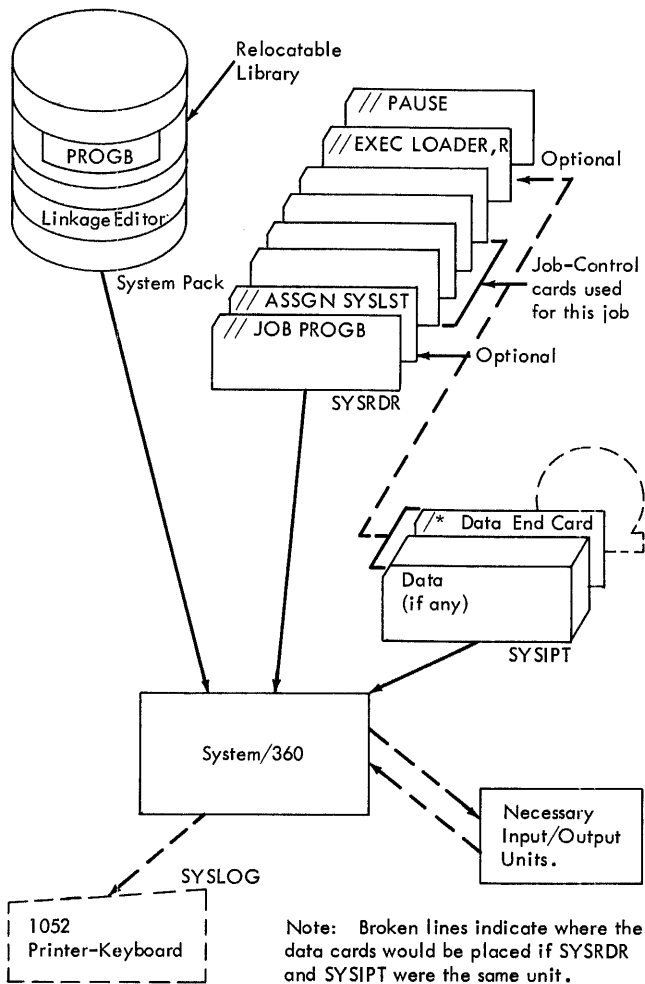

Figure 8. Example 2: Program is in the Relocatable Library--Link-and-Execute (Part 1 of 2)

Card Arrangement	Comments
<pre>// JOB program-name // ASSGN SYSLST,... } Job Control cards } used for this job // EXEC LOADER,R Data, if any Data End Card, if needed</pre>	Optional; used by Linkage Editor

Figure 8. Example 2: Program is in the Relocatable Library--Link-and-Execute (Part 2 of 2)

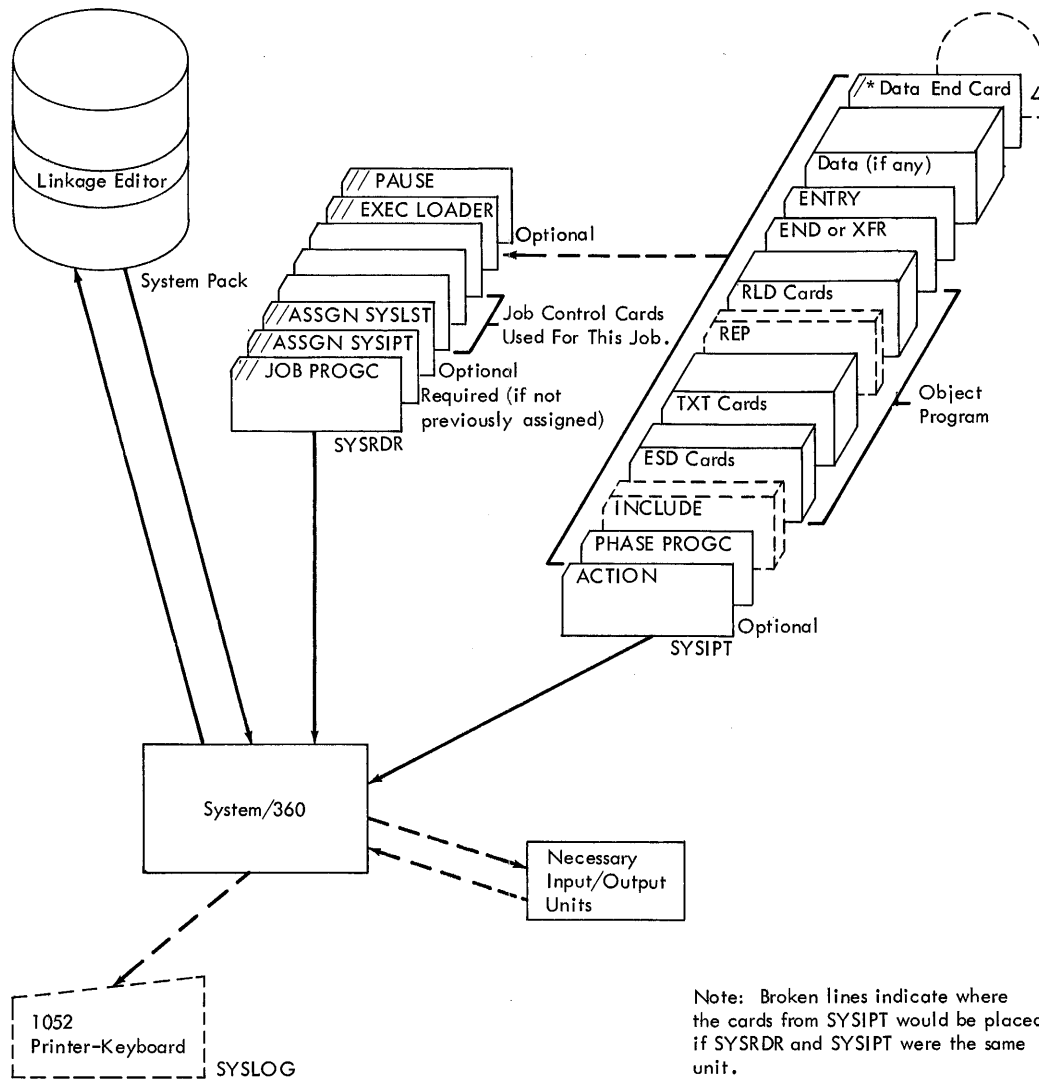

Figure 9. Example 3: Program is in Cards or in Card-Image on Tape -- Link-and-Execute (Part 1 of 2)

Card Arrangement	Comments
<pre> // JOB program-name // ASSGN SYSIPT,... // ASSGN SYSLST,..... . . . } Job control cards . } used for this job . // EXEC LOADER ACTION CLEAR ACTION NOMAP PHASE program-name INCLUDE ESD TXT REP RLD END or XFR ENTRY } Linkage } Editor } Input Data, if any Data End Card, if needed // PAUSE </pre>	<pre> Required, unless previously assigned. Optional; used by Linkage Editor Optional Optional Optional Optional </pre>

Figure 9. Example 3: Program is in Cards or in Card-Image on Tape --
Link-and-Execute (Part 2 of 2)

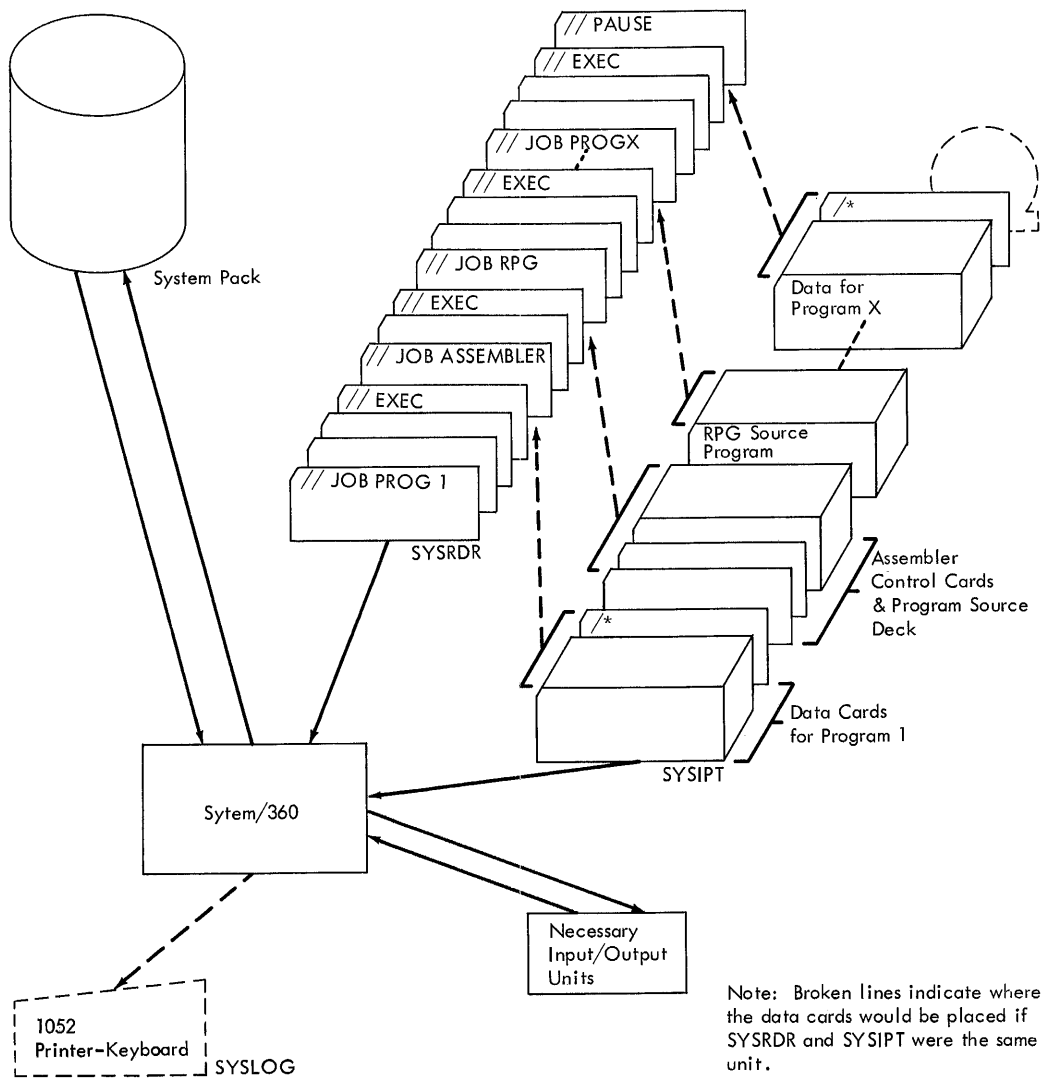

Figure 10. Example 4: Stacked Jobs

TERMINATING A JOB

The operator can initiate job termination, or he can terminate a job by replying to an error message. Figure 11 illustrates the steps for initiating job termination (steps 1-5) and for replying to a message (steps 2-5). In either case, entering a code 0 terminates the job, and a code 1 causes a printout of main storage and terminates the job.

Note: If the operator wishes to terminate a job and obtain a storage printout at any logical IOCS message (4nnnA), the utility storage print program should be used instead of giving a reply of 1. (The reason is that the OPEN/CLOSE/EOF/EOV routines are either in the transient area, or have required information in the transient area (labels, control card records, etc.)). The transient area is used (and destroyed) by the system storage print routine, which is executed when a 1 is given to the supervisor.

STEP	PROCEDURE	COMMENTS
1	Press REQUEST on the 1052, or Press STOP on the console, or Omit this step if a message has just been issued.	If a 1052 Printer-Keyboard is available. The system acknowledges the request with a message (0702A) on the 1052 and PROCEED lights up. If a 1052 Printer-Keyboard is not available.
2	Remove any data cards from SYSIPT (unless SYSIPT is the same device as SYSRDR).	Any data cards in SYSRDR need not be removed because Job Control bypasses them.
3	Change forms on the printer, if necessary.	The hexadecimal storage printout has 120 characters/line.
4	Place a PAUSE card in SYSRDR, or Set up the next job, if possible. (Place its job-control cards in SYSRDR.)	
5	Type 0 or 1 and the end-of- block code on the 1052 and press INTERRUPT. or Store 0 or 1 in byte 5 through the console (and check it in the console lights). Then press INTERRUPT and START.	If a 1052 is available. If a 1052 is not available. Processing of the current program is discontinued. <u>Code</u> <u>Meaning</u> 0 Job Control is to search for the next job-control card in SYSRDR and processing is to continue without interruption. 1 The contents of main storage are to be printed on SYSLST. (If SYSLST is not assigned, the job is terminated as if a code of 0 had been given.) Job Control is to search for the next job control card in SYSRDR and processing is to continue without interruption.

Figure 11. Terminating a Job

RESTARTING A CHECKPOINTED JOB

Restarting is the process of resuming the execution of a program that was terminated after a checkpoint was taken. Figure 12 illustrates the procedure for restarting a job. Figure 13 shows the job-control cards used.

(The system is in the wait state)

STEP	PROCEDURE	COMMENTS
1	Ready the input/output units used by the program to be restarted.	
2	Ready the tape or disk unit that contains the checkpoint records.	
3	Place job-control cards in SYSRDR.	See Figure 13 for necessary job-control cards.
4	Press START and INTERRUPT.	

Figure 12. Restarting a Checkpointed Job

Card Arrangement	Comments
<pre>// JOB program-name // RSTRT or // RSTRT SYSxxx,kkkk . } Any job . } control cards . } needed for . } this program // ASSGN // FILES SYSxxx,n // EXEC</pre>	<p>If the checkpoint is on disk.</p> <p>If the checkpoint is on tape.</p> <p>Label cards must be resubmitted.</p> <p>Assignment(s) for symbolic units referred to in a FILES card.</p> <p>If tape files are to be positioned beyond tape marks.</p>

Figure 13. Job Control Cards Used When Restarting

SYSTEM/OPERATOR COMMUNICATION

Communication between the IBM System/360 and the machine operator is of two types:

1. Communication from the system to the operator.
2. Communication to the system, initiated by the operator.

Communication from the system to the operator is required for efficient operation and control of the system. Coded messages are either displayed on the system control panel (console) or printed on an IBM 1052 Printer-Key-board, if one is available (and assigned to SYSLOG).

The wait state is entered after every message issued on the console. When messages are issued via a 1052, the wait state is entered only after messages which require a reply.

Communication initiated by the operator may be used to process inquiries and also for system control. The operator can communicate only to the supervisor via the system control panel switches and keys. He can communicate to either the supervisor or the problem program when a 1052 Printer-Key-board is available (and assigned to SYSLOG).

In some cases, communication between the system and the operator may utilize a printer or an inquiry display terminal. A printer can give instructions and messages to the operator. An inquiry display terminal can handle operator instructions and inquiries, and replies from the system.

COMMUNICATION FROM THE SYSTEM TO THE OPERATOR

Coded Messages (MSG Macro)

Communication to the operator can be handled from IBM-supplied programs and the user's problem programs through a program instruction called the MSG (Message) macro. This macro prints a five-character coded message on a 1052, or stores it in bytes 0-4 of main storage, where it can be displayed on the console by the operator. These messages may be a numerical code, or some set of meaningful characters (for example, ISEQ for Input Sequence Error). IBM-supplied programs generally use an alphanumeric code. The form of the message is nnnnA or nnnn. The first character of the message identifies its source (Figure 14).

Some messages require a reply from the operator to continue processing. When a reply is required, the letter A is the fifth character of the message and is printed on the 1052 following the 4-character message. If no 1052 is available, the letter A can be displayed on the console from byte 4 of main storage. When a reply is not required, the fifth character of the message is a blank.

A reply is always a single character; any character may be a valid reply as defined by a user-written program. The characters 0, 1, 2, 3, 4, and 5 (Figure 15) are replies to any program using an IBM-supplied supervisor.

Messages beginning with a 0 or a 4 may be two-part messages (actually two messages). The fifth character of the first of these messages is blank when a second message follows. It is an A when there is no second message.

Identifying Message Code		Message Issued by
Printed on 1052 Printer-Key-board	Displayed on Console from Byte 0	
0nnn	1111 0000	IPL or Supervisor (Including Physical IOCS)
1nnn	1111 0001	Job Control
2nnn	1111 0010	Linkage Editor
3nnn	1111 0011	Other IBM Programs
4nnn	1111 0100	Logical IOCS

Figure 14. Message Identification

Coded Operator Reply*		Meaning
1052	Console Byte 5	
0	00 or F0	Terminates the job (Job Control searches for the next job-control card in SYSRDR and processing continues)**
1	01 or F1	Prints out main storage and terminates the job.**
2	02 or F2	Turns on program switch 7 in the UPSI byte of the communication region.
3	03 or F3	Turns off program switch 7 (UPSI byte).
4	F4	Ignores the indicated I/O error and continue processing if physical IOCS initiated the message (see <u>Error Messages: Physical IOCS</u>). If not physical IOCS initiated, reply and control are returned to the program that initiated the message.
5	F5	Retries the indicated I/O operation if physical IOCS initiated the message (see <u>Error Messages: Physical IOCS</u>). If not physical IOCS initiated, reply and control are returned to the program that initiated the message.

*Each reply (except 0 or 1) is returned to the program (IBM-supplied or user-written program) that initiated the message. Then the program can analyze the reply and perform the appropriate function.
**See the section Terminating a Job for more information.

Figure 15. Replies to Messages (Using IBM-supplied Supervisor)

When a two-part message is issued, the two parts are printed on the IBM 1052 Printer-Keyboard, if one is available in the system. The first part (or first message) has the form 0nnn or 4nnn, in which nnn is the channel and unit address of the I/O device in which the error occurred. The second part of the message (or second message) indicates the type of error. Its form is nnnnA or 4nnnA.

When a 1052 is not available, the operator must display main storage bytes 0-4 for the first message. If byte 4 is blank, he must then press the start and interrupt keys, and display bytes 0-4 for the second message. If byte 4 contains an A, this is the only message and it indicates the type of error.

OPERATOR REPLY VIA THE 1052 PRINTER-KEYBOARD: Figure 16 illustrates the procedure for replying to an error message when a 1052 Printer-Key-board is available.

STEP	PROCEDURE	COMMENTS
1	Observe the 1052 PROCEED light.	It is on when a message reply is required. (Processing is suspended until the reply is given.)
2	Type the appropriate reply.	From a prepared list of messages and required responses. If a wrong reply is typed accidentally, the operator must enter the correct reply through the console: Press STOP. Enter the correct reply in byte 5. Press START.
3	Type an end-of-block (EOB) character and press INTERRUPT.	(Hold ALT CODE down and type a 5.) The system resumes processing.
<p>Note: If an input/output error (other than wrong-length-record) occurs during the operator response, the system enters the wait state (WAIT lights up on the console). The operator must store the response in byte 5 of main storage.</p>		

Figure 16. Operator Reply via the 1052 Printer-Key-board

OPERATOR REPLY VIA THE SYSTEM CONTROL PANEL: Figure 17 illustrates the procedure for replying to an error message when a 1052 Printer-Key-board is not available.

STEP	PROCEDURE	COMMENTS
1	Observe the WAIT light on the console.	It is on when the system is in the wait state.
2	Press STOP.	
3	Display bytes 0-4 of main storage.	When a reply is required, an A (1100 0001) is in byte 4.
4	Store the appropriate reply in byte 5 (and check it in the console lights).	This step can be omitted when a reply of blank is desired.
5	Press START and INTERRUPT.	The system resumes processing.

Figure 17. Operator Reply via the System Control Panel (Console)

Error Codes (Byte 32)

When the Supervisor detects an I/O error from which no automatic recovery is possible, FFFF (hexadecimal) appears in the B and A registers on the console and the wait state is entered. The operator must display main-storage byte 32 (hexadecimal) to obtain the error code. These codes and their meanings are listed in the Operator Messages Manual referenced on the front cover of this publication.

Error Codes (Bytes 18-1D)

Additional information, called sense information, concerning certain input/output errors is in main-storage bytes 18-1D (hexadecimal). The first two bytes (18 and 19) are used when a message is issued via the message (MSG) macro. The last four bytes (1A-1D) contain information that may be useful under certain conditions. For example, when a disk unit has an error and a

message is issued, bytes 1A-1D contain cylinder and head information (in the form cchh) connected with the disk error. A description of this sense information is given in the publication for each I/O unit. (See the IBM System/360 Bibliography; its form number is listed on the front cover of this publication.)

Other Messages

Some messages may be issued from the problem program by means other than the MSG macro. These messages may be in sentence form, giving instructions to the operator or information about the status of the system or program. These messages may appear on the 1052 or on the 1403 or 1443 printers of the system. Some examples are:

```

PHASE A COMPLETED
I-O DATA CHECK ERROR
UNIT UNAVAIL
  
```

COMMUNICATION INITIATED BY THE OPERATOR

Communication initiated by the operator can be to the Supervisor or to the problem program. When a 1052 Printer-Keyboard is available, communication is possible to both the Supervisor and the problem program. When a 1052 is not available, communication

is possible only with the Supervisor. Figure 18 illustrates the procedure for operator-initiated communication to the Supervisor, using the system control panel (console).

For the operator to communicate with the problem program:

1. The 1052 Printer-Keyboard must be available and must be assigned to SYSLOG.
2. CR=YES must have been specified in the supervisor assembly.
3. A user-written routine to process the communication must be present in main storage and activated.
4. The operator must have a prepared list of codes and inquiries (if required) acceptable to the problem program.

Figure 19 illustrates the procedure for operator-initiated communication to the Supervisor or the problem program using the 1052 Printer-Keyboard.

Note: An inquiry display terminal can also be used by the operator to communicate with the problem program. A user's routine must be present to handle this request, process and display a reply, and return control to the Supervisor.

STEP	PROCEDURE	COMMENTS										
1	Press STOP.											
2	Store the appropriate code in byte 5 (and check it in the console lights).	<table border="0"> <thead> <tr> <th><u>Code</u></th> <th><u>Meaning</u></th> </tr> </thead> <tbody> <tr> <td>00 or F0</td> <td>Terminate the job.</td> </tr> <tr> <td>01 or F1</td> <td>Printout main storage and terminate the job.</td> </tr> <tr> <td>02 or F2</td> <td>Set UPSI bit 7 <u>on</u> and continue processing.</td> </tr> <tr> <td>03 or F3</td> <td>Set UPSI bit 7 <u>off</u> and continue processing.</td> </tr> </tbody> </table>	<u>Code</u>	<u>Meaning</u>	00 or F0	Terminate the job.	01 or F1	Printout main storage and terminate the job.	02 or F2	Set UPSI bit 7 <u>on</u> and continue processing.	03 or F3	Set UPSI bit 7 <u>off</u> and continue processing.
<u>Code</u>	<u>Meaning</u>											
00 or F0	Terminate the job.											
01 or F1	Printout main storage and terminate the job.											
02 or F2	Set UPSI bit 7 <u>on</u> and continue processing.											
03 or F3	Set UPSI bit 7 <u>off</u> and continue processing.											
3	Press INTERRUPT and START.	The system analyzes the code and functions accordingly. (If a code other than those listed is entered, it is ignored.)										

Figure 18. Operator-initiated Communication to the Supervisor via the Console

STEP	PROCEDURE	COMMENTS												
1	Press REQUEST	The system acknowledges the request with a message (0702A) on the 1052.												
2	Observe the 1052 PROCEED light	It should be <u>on</u> .												
3	Type the appropriate code, the end-of-block code, and press INTERRUPT. Communication to an IBM-supplied Supervisor	The system analyzes the code and functions accordingly. <table border="0"> <thead> <tr> <th>Code</th> <th>Meaning</th> </tr> </thead> <tbody> <tr> <td>0</td> <td>Terminate the job.</td> </tr> <tr> <td>1</td> <td>Printout in storage and terminate the job.</td> </tr> <tr> <td>2</td> <td>Set UPSI bit 7 <u>on</u> and continue processing.</td> </tr> <tr> <td>3</td> <td>Set UPSI bit 7 <u>off</u> and continue processing.</td> </tr> <tr> <td>Other</td> <td>Transfer control the problem program routine for processing.</td> </tr> </tbody> </table>	Code	Meaning	0	Terminate the job.	1	Printout in storage and terminate the job.	2	Set UPSI bit 7 <u>on</u> and continue processing.	3	Set UPSI bit 7 <u>off</u> and continue processing.	Other	Transfer control the problem program routine for processing.
Code	Meaning													
0	Terminate the job.													
1	Printout in storage and terminate the job.													
2	Set UPSI bit 7 <u>on</u> and continue processing.													
3	Set UPSI bit 7 <u>off</u> and continue processing.													
Other	Transfer control the problem program routine for processing.													
4	If an inquiry is to be entered, observe the PROCEED light. Otherwise, the communication is ended.	It should be <u>on</u> .												
5	Type the inquiry.	When the inquiry is shorter than or equal to the maximum allowable size, also type an end-of-block character (hold ALT CODE down and type a 5). (When the inquiry is longer than the maximum allowable size, a wrong-length record results.)												

Figure 19. Operator-initiated Communication to the Supervisor or the Problem Program via the 1052

SELECTED CONSOLE INFORMATION

For the operator's convenience, selected information on the IBM System/360 Model 30 system control panel is presented in this section. For further information on the purpose and use of the 2030 system control panel, refer to the IBM System/360 Model 30 Operator's Guide, listed on the front cover of this publication.

Part of the 2030 system control panel (Figure 20) provides manual controls and indicator lights that serve as an operator's system control console. This console serves many functions, some of which are:

1. Displaying information from main storage (Figure 21).
2. Manually storing information into main storage (Figure 22).

The lower section of the console contains keys, rotary switches, and indicator lights that enable the operator to enter or display information into or from main storage.

Rotary switches A, B, C, and D are used to set up the address for manual operations involved with main storage. Rotary switches H and J are used to set up the data to be entered into storage.

The display storage selection switch (rotary switch E) is used to select the particular area to be addressed for display or storage. For example, if a location in main storage is to be displayed, set the display storage selection switch to the MS position.

The main-storage address register (left center of console) displays the address dialed in rotary switches A, B, C, and D when either displaying or storing information. The address is indicated by the half-byte binary values (8421) that are lighted. The hexadecimal/binary decal under rotary switches A, B, and C can be used to convert the binary values to hexadecimal.

The main-storage data register (left center of console) displays the data dialed in rotary switches H and J, after the data

has been entered into main storage. The data is also indicated by the halfbyte binary values (8421) that are lighted.

STEP	PROCEDURE	COMMENTS
1	Observe the TEST and ALLOW WRITE lights.	They must be off, otherwise a manual display is not possible.
2	Press STOP.	The system stops after the current instruction is processed. MAN lights up.
3	Set DISPLAY STOR SEL (rotary switch E) to MS.	
4	Dial the address of the desired byte in rotary switches A, B, C, and D.	For example, to display byte 32, convert to hexadecimal 0020; then set rotary switch A to 0, B to 0, C to 2, and D to 0.
5	Press DISPLAY.	The address of the selected location is displayed in the main-storage address register. (Check the address for accuracy.) The data stored in the selected location is displayed in the main-storage data register.

Figure 21. Displaying Information From Main Storage

STEP	PROCEDURE	COMMENTS
1	Observe the ALLOW WRITE light.	It must be off, otherwise storing information is not possible.
2	Press STOP.	The system stops after the current instruction is processed. MAN lights up.
3	Set DISPLAY STOR SEL (rotary switch E) to MS.	
4	Dial the address of the byte to be altered in rotary switches A, B, C, and D	For example, to alter byte 5 of main storage, set rotary switch A to 0, B to 0, C to 0, and D to 5.
5	Dial the byte of information to be stored in rotary switches H and J.	The information stored is in hexadecimal form. For example, if the operator is responding to a supervisor message with a reply of 3, rotary switches H and J are set to 0 and 3, respectively.
6	Press STORE.	The <u>address</u> of the byte to be altered is displayed in the main-storage address register. (Check the address for accuracy.) The <u>byte of information</u> stored is displayed in the main storage data register. (Check this information to determine if it has been entered correctly.)
7	Press START.	

Figure 22. Storing Information In Main Storage

ASSEMBLER

The Assembler program produces a machine-language object program from a user-written source program. The operating procedures are arranged, for the convenience of the operator, in eight quick-reference charts, or figures.

Device Assignments (Figure 23) lists the required and optional input/output units, and the symbolic units which identify them. The function of each device is also listed. Figure 24 illustrates the I/O units used.

The Source Deck (Figure 25) lists and explains the card groups which make up the source deck, and the order in which they must appear.

Assembler Control Cards (Figure 26) gives the use and functions of the ALOG, AOPTN, AWORK, and AFILE control cards.

Disk Label Cards (Figure 27) lists the disk label cards required by the Assembler with their contents.

Assembler Output Deck (Figure 28) lists and explains the card groups of the object deck, the conditions of their assembly, and the order in which they are produced.

The Output Listing (Figure 29) presents the output-listing format, its information groups, and the fields within these groups.

Assemble-and-Execute (Figure 30) lists the cards needed to combine the assembly and execution of a user's program. Figure 30 shows the input/output units used.

Operating Considerations (Figure 31) contains other information for the operator.

Symbolic Unit	Function and Device
Required Device Assignments	
SYSRDR	Job-control input device. May be the same device as SYSIPT. IBM 1442, 2520, or 2540 Card Read Punch, or 2501 Card Reader.
SYSIPT	Source program input device. May be the same device as SYSRDR. IBM 1442, 2520, or 2540 Card Read Punch, or 2501 Card Reader. IBM 2400-series Magnetic Tape Unit (7- or 9-track) may be used. (If the Data Conversion Feature was used to prepare the 7-track tape, it must also be used to read the tape). The tape records must be 80-byte unblocked records.
SYSOPT	Object program output device. IBM 1442, 2520, or 2540 Card Read Punch. IBM 2400-series Magnetic Tape Unit (9-track, or 7-track with Data Conversion Feature) may be used. Output on tape is in 80-byte unblocked records.
SYSLST	Program listing device. IBM 1403, 1404 (continuous forms only), or 1443 Printer. IBM 2400-series Magnetic Tape Unit (9-track, or 7-track with or without the Data Conversion Feature) may be used. Listing on tape appears as 121-character print images (a single forms-control byte followed by a 120-character line image). (This forms-control byte is the command code portion of the CCW used during print-out).
SYS000	Used for temporary work area during assembly. IBM 2311 Disk Storage Drive. May be the same as the system residence device.
Optional Device Assignments	
SYSLOG	Operator message logging device. IBM 1052 Printer-Keyboard, or IBM 1403, 1404 (continuous forms only), or 1443 Printer.
SYS001	Used for temporary work area during assembly. IBM 2311 Disk Storage Drive. Reduces assembly time by providing additional work area on a separate disk drive. (See the AWORK option in Figure 26).
For any of the above device assignments, the Supervisor must contain the corresponding errors routines.	

● Figure 23. Device Assignments

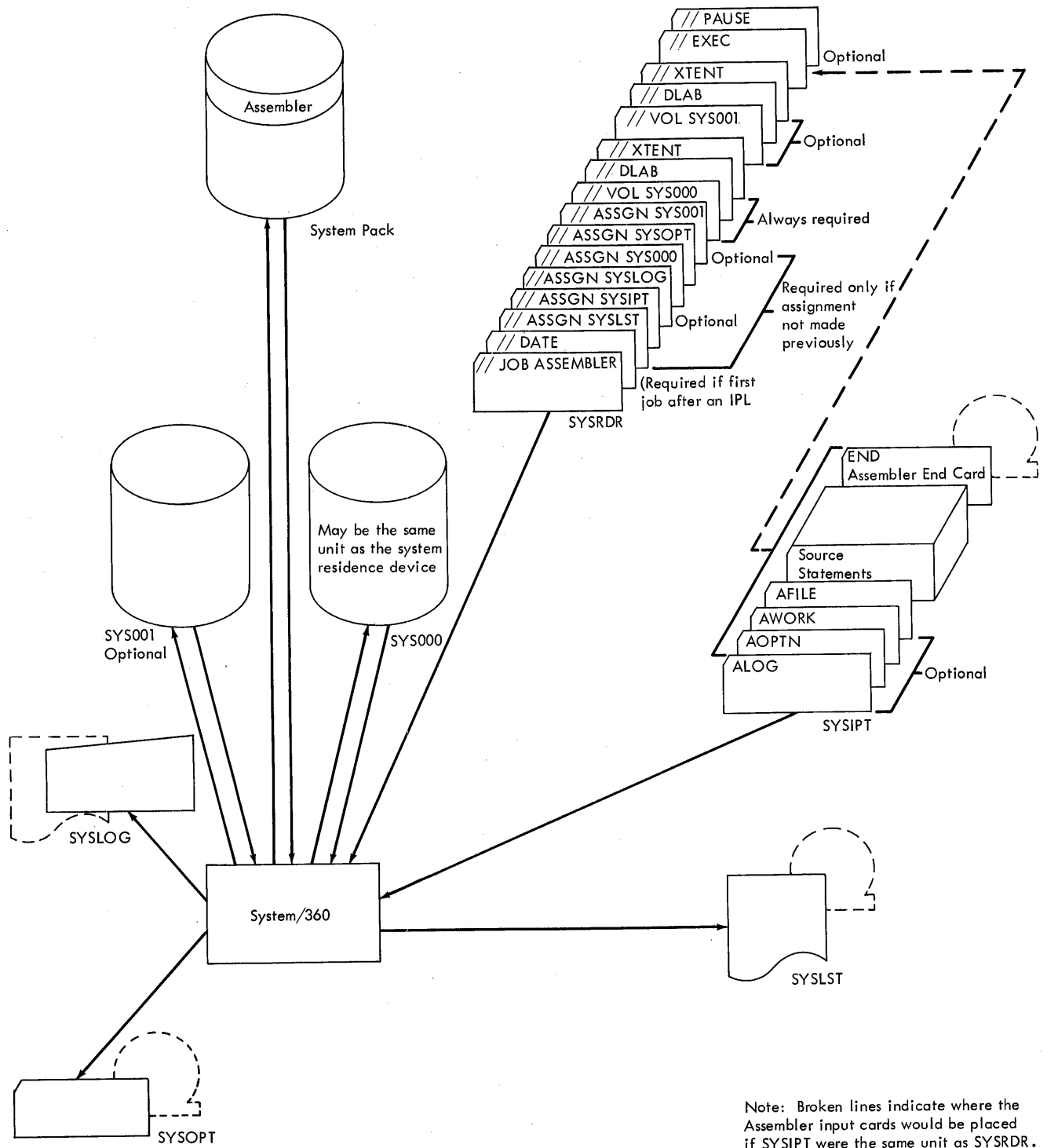

Figure 24. I/O Units used by the Assembler Program

Figure 25 lists the card groups that make up the source deck produced by the programmer, with an explanation of each group. The groups are listed in the order in which they appear in the source deck.

All job-control cards must enter the system via SYSRDR, all others via SYSIPT. (The same device may be assigned to both SYSRDR and SYSIPT.)

Card Group	Card Arrangement	Comments
Job-Control Cards	// JOB ASSEMBLER // DATE // ASSGN // VOL // DLAB // XTENT // VOL // DLAB // XTENT // EXEC	First card in group. Always required. Assemble-and-Execute is initiated when the name of the problem program appears as the second operand. Required on first job after IPL. See Figure 23 for Device Assignments. (Only those assignments not already in effect are required.) Required for SYS000 (all assemblies). See Figure 27 for operands. Required for SYS001 (when the AWORK2 option is used). See Figure 27 for operands. Last card in group. Always required.
Assembler Control Cards	ALOG AOPTN AWORK AFILE	See Figure 26 for explanation of use and function. These cards may appear in any order.
Supervisor-assembly Source Cards	SUPVR SYMUN IOCFG SEND	Either a BOS or independent supervisor may be assembled.
Problem-program Source Cards	Assembler, Machine, and Macro statements.	REPRO and PHASE cards <u>must</u> be present if Assemble-and-Execute is specified. START card <u>may</u> be omitted if a problem program is assembled alone (START 0 assumed). START card <u>must</u> be omitted if a supervisor is assembled.
End Card	END	Last card of source deck.

Figure 25. The Source Deck

The control cards in Figure 26 have the same format as assembler statements. ALOG, AOPTN, AWORK, and AFILE appear as if they were mnemonic operation codes.

Each option of the AOPTN card may be specified in a different AOPTN card or they may appear as multiple operands (separated by commas) in a single card. (No continuation cards may be used.)

One or More Blanks	Operation	One or More Blanks	Operand	Meaning
	ALOG		(Anything appearing here will be treated as comments.)	The contents of the ALOG card, the contents of all assembler-option cards following the ALOG card, and a statement of the total number of errors will be printed out on SYSLOG.
	AOPTN		NODECK	The object deck will not be produced, in cards, or on tape or disk. This will not affect the appearance of the program listing. Also, no cards will be reproduced as a result of REPRO or PUNCH instructions.
	AOPTN		NOESD	No External Symbol Dictionary data will appear in the object deck or, the program listing. (Program will not be acceptable to a basic operating system or an operating system.)
	AOPTN		NORLD	No Relocation Dictionary data will appear in the object deck or the program listing. (Program may not be relocatable.)
	AOPTN		NOLIST	The program listing will not appear.
	AOPTN		NOERR	The error listing will not appear in the program listing.
	AOPTN		NOSYM	The symbol table will not appear in the program listing.
	AOPTN		IPL	An IPL routine (for loading as independent supervisor from a card reader) will precede the object program.
	AOPTN		PCHSYM	The symbol table is put out on the device specified for text output. This table is required by the Auto-test program, if its symbolic testing capabilities are to be used.
	AOPTN		CROSSREF	A cross-reference listing will appear instead of the symbol table listing. The cross-reference listing contains all the symbols used in the program and the statement numbers of statements in which they were used.

Figure 26. Assembler Control Cards (Part 1 of 2)

One or More Blanks	Operation	One or More Blanks	Operand	Meaning
	AOPTN		ENTRY	An ENTRY card will be produced at the end of the output text. Otherwise it must be placed there manually, before link-editing.
	AOPTN		BGNBATCH	The assembler assumes another source deck is to be assembled immediately; that is, a batched environment is assumed*. <u>Note:</u> If SYSLST and SYSOPT are assigned to tape, the tapes are opened, but are <u>not</u> closed at the end of the assembly.
	AOPTN		BATCH	A batched environment is continued. If listing or output tapes are used, they will <u>not</u> be closed*.
	AOPTN		ENDBATCH	The batch environment is ended and end of job will be called. If SYSLST and SYSOPT are assigned to tape, the tapes will be closed*.
	AWORK		1	The assembler assumes one work area.
	AWORK		2	The assembler assumes two work areas. If the AWORK card is omitted, the assembler assumes one work area.
	AFILE		LIBRARY	The assembler will place the assembled object program in the relocatable library as a module. The next module placed in the relocatable library <u>will</u> overlay this program. The module name must appear in the name field of the AFILE card.
	AFILE		LIBRARY,RETAIN	The assembler will place the assembled object program in the relocatable library as a module for permanent storage. Modules placed in the relocatable library at a later time <u>will not</u> overlay this program. The module name must appear in the name field of the AFILE card.
<p>* The batched environment is used to assemble several independent source programs with one assembler run. AOPTN BGNBATCH immediately precedes the first source program, AOPTN BATCH immediately precedes each source program between the first and last one, and ENDBATCH immediately precedes the last source program.</p>				

● Figure 26. Assembler Control Cards (Part 2 of 2)

Figure 27 lists the disk label cards required by the Assembler, and their contents. The details for punching these cards are given in Card Formats: Job Control Cards.

Card	Field	Contents
Required for all assemblies.		
VOL	Symbolic Unit File Name	SYS000 WORK1
DLAB	File Name Format Identifier File Serial Number Volume Sequence Number Creation Date Expiration Date System Code	BOS 8K DISK WORK FILE 1 1 Required 0001 Today's Date Today's Date Optional
XTENT	Extent Type Extent Sequence Number Lower Limit of Extent Upper Limit of Extent Volume Serial Number Symbolic Unit	1 000 (Define the area, on the disk pack assigned to SYS000, to be used by the assembler.) Must be the same as DLAB File Serial Number. SYS000
Required only when the AWORK 2 option is used.		
VOL	Symbolic Unit File Name	SYS001 WORK2
DLAB	File Name Format Identifier File Serial Number Volume Sequence Number Creation Date Expiration Date System Code	BOS 8K DISK WORK FILE 2 1 Required 0001 Today's Date Today's Date Optional
XTENT	Extent Type Extent Sequence Number Lower Limit of Extent Upper Limit of Extent Volume Serial Number Symbolic Unit	1 000 (Define the area, on the disk pack assigned to SYS001, to be used by the assembler.) Must be the same as DLAB File Serial Number. SYS001

● Figure 27. Disk Label Cards

Figure 28 lists the card groups that make up the output deck produced by the assembler, and the conditions of their assembly. The groups are listed in the order in which they appear in the output deck. Note: No output deck will be produced when NODECK appears in AOPTN.

Card Group	Remarks
IPL routine	Used for loading an independent supervisor from a card reader. Produced when IPL appears in AOPTN.
Reproduced Cards	These reproduced cards result from REPRO or PUNCH instructions located before START.
Symbol Table (SYM)	Produced when PCHSYM appears in AOPTN.
External Symbol Dictionary (ESD)	Produced except when NOESD appears in AOPTN.
Supervisor	Either a BOS or an independent supervisor may be produced.
Program Loader	Produced as part of the independent supervisor.
Problem Program	Consists of TXT, XFR, and reproduced cards. The reproduced cards result from REPRO or PUNCH instructions located after START.
Relocation Dictionary (RLD)	Produced if relocatable constants are present, except when NORLD appears in AOPTN.
END Card	Produced as the last card of the output deck. (Next to last if an ENTRY card is produced.)
ENTRY Card	Produced as the last card of the output deck when ENTRY appears in AOPTN.
Object Deck Identification	
The 4-character assembly identification label punched into the name field of the first TITLE card in the source program is punched into columns 73-76 of each record in the object deck. If there is no label, these columns are left blank.	
Object Deck Sequence Numbering	
An assembler-generated sequence number is punched into columns 77-80 of each card in the object deck.	

Figure 28. Assembler Output Deck

EXTERNAL SYMBOL DICTIONARY						
SYMBOL	TYPE	ID	ADDR	LENGTH	LD	ID
SAMPLE	SD	01	0012C0	0002E3		

12/31/65 PAGE 001						
LOCATN	OBJECT CODE	ADDR1	ADDR2	STMNT	SOURCE STATEMENT	
				0001	AOPTN ENTRY,CROSSREF	SMPLO001

12/31/65 PAGE 002								
LOCATN	OBJECT CODE	ADDR1	ADDR2	STMNT	SOURCE STATEMENT			
				0003	ISEQ 77,80	SMPLO003		
				0004	PUNCH ' PHASE SAMPLE,S'	SMPLO004		
				0005	SAMPLE START 4800	SMPLO005		
				0006	PRINT NOGEN	SMPLO006		
				0007	DTFRG DISK	SMPLO007		
				0009	PRINT DTFSR BLKSIZE=100,CONTROL=YFS,DFVADDR=SYSLST,DEVICE=PRINTER,TOX	SMPLO008		
				0010	AREAL=KAPA,RECFORM=FIXUNB,TYPEFLE=OUTPUT	SMPLO009		
				0057	DTFEN	SMPLO010		
001338	0550			0059	BEGIN BALR 5,0	SMPLO011		
00133A				0060	USING *,5	SMPLO012		
				0061	OPEN PRINT	SMPLO013		
				0070	CNTRL PRINT,SK,1	SMPLO014		
001362	1833			0077	SR 3,3	SMPLO015		
001364	4120	5009	01413	0078	LA 2,MESSAGE	SMPLO016		
001368	D263	5075	2000	013AF	0000	0079	MOVE MVC KAPA,0(2)	SMPLO017
				0080	PUT PRINT	SMPLO018		
001378	4133	0001	00001	0085	LA 3,1(3)	SMPLO019		
00137C	4230	5074	013AE	0086	STC 3,TEST	SMPLO020		
001380	9504	5074	013AE	0087	CLI TEST,X*04'	SMPLO021		
001384	4780	5058	01392	0088	BE ENDPROG	SMPLO022		
001388	4122	0064	00064	0089	LA 2,100(2)	SMPLO023		
00138C	47F0	502E	01368	0090	B MOVE	SMPLO024		
				0091	ENDPROG CNTRL PRINT,SK,1	SMPLO025		
				0098	EDJ	SMPLO026		
0013AE				0104	TEST DS CLI	SMPLO027		
0013AF				0105	KAPA DS CL100	SMPLO028		
001413	40C9C2D440C2C1E2			0106	MESSAGE DC CL100' IBM BASIC OPERATING SYSTEM/360 '	SMPLO029		
001477	404040D6D7C5D9C1			0107	DC CL100' OPERATING GUIDE- (RK DISK) '	SMPLO030		
0014DB	40C3D6D5E3D9D6D3			0108	DC CL100' CONTROL PROGRAMS AND ASSEMBLER '	SMPLO031		
00153F	4B484B4848484848			0109	DC CL100'.....'	SMPLO032		
001338				0110	END BEGIN	SMPLO033		

Figure 29. Example of an Assembler Listing (Part 1 of 2)

RELOCATION DICTIONARY

POS.ID REL.ID FLGS ADDR

01 01 0C 0012C0
 01 01 04 0012CA
 01 01 08 0012CD
 01 01 04 0012E4
 01 01 08 0012F9
 01 01 04 001314
 01 01 04 001320
 01 01 08 001329
 01 01 0C 001334
 01 01 0C 001350
 01 01 0C 00135C
 01 01 0C 001374
 01 01 0C 001398

POS.ID - Relocation factor of the contents of
 the load constant.
 REL.ID - Relocation factor of the control section
 in which the constant appears.
 FLGS - Flag indicating the type of constant
 (A-type, V-type, etc.)
 ADDR - Assembled address of load constant.

DIAGNOSTICS

NO ERRORS IN THIS ASSEMBLY

CROSS REFERENCE LISTING - DISK ASSEMBLER, 8K

SYMBOL LEN VALUE DEF CROSS-REFERENCE

BEGIN 002 001338 0059 0110
 ENDPROG 004 001392 0094 0088
 ICCB0003 002 00131A 0048 0042 0046
 ICCW0003 008 001328 0052 0044 0051
 IGCB0003 002 0012C4 0016 0033 0034
 IGCW0003 008 0012F8 0038 0019 0030
 IDCC0005 004 001350 0069 0064
 IPRR0003 001 0012F2 0037 0031
 IPRT0003 004 0012E6 0034 0035
 KAPA 100 0013AF 0105 0015 0038 0079
 MESSAGE 100 001413 0106 0078
 MOVE 006 001368 0079 0090
 PRINT 001 0012C0 0014 0024 0029 0041 0055 0069
 PRINTA 004 001334 0055 0028 0040
 PRINTB 001 001330 0053 0030 0031
 PRINTC 004 001300 0040 0052 0075 0096
 PRINTP 004 0012D2 0028 0084
 SAMPLE 000 000000 0005
 TEST 001 0013AE 0104 0086 0087

Note: The maximum number of symbols and
 cross-references to symbols that can
 be listed is 20,625.

● Figure 29. Example of an Assembler Listing (Part 2 of 2)

Figure 30 shows the order of the cards that are submitted to execute a program immediately after it is assembled. Figure 31 shows the I/O units used by the assembler program for Assemble-and-Execute.

Card Group	Card Arrangement	Comments
Job Control	<pre>// JOB ASSEMBLER, program-name // DATE // ASSGN SYSLST,..... // ASSGN SYSIPT,..... // ASSGN SYSOPT,..... // ASSGN SYSLOG,..... // ASSGN SYS000,..... // ASSGN SYS001,..... // VOL SYS000,.... // DLAB // XTENT // VOL SYS001,.... // DLAB // XTENT // EXEC</pre>	<p>The name of the problem program must appear as the second operand of the JOB card.</p> <p>Required only if this is the first job after an IPL.</p> <p>Optional</p> <p>Optional - Required if AWORK 2 is included.</p> <p>Optional } Optional } Required if AWORK 2 is Optional } included.</p> <p>Required</p>
Assembler Input	<pre>AOPTN ENTRY AFILE AWORK 2 . } Any other assembler . } control cards desired . } REPRO PHASE..... } Program Source Deck } END</pre>	<p>Required</p> <p>Required</p> <p>Optional</p> <p>Required</p>
Data	<pre>Data, if any Data End Card, if needed</pre>	
Job Control	<pre>// PAUSE</pre>	Optional job control card

● Figure 30. Cards Submitted for Assemble-and-Execute

Endless Loop. Errors in the coding of a macro definition (handling of the inner macro calls and AIFB and AGOB statements) can cause an endless loop during the first assembler pass. This loop may be ended by turning on UPSI bit 7 (see Communication Initiated by the Operator). This will stop further processing of AIFB and AGOB statements and inner macro instructions, allowing the assembly to proceed.

Macro Error Message. If an error condition of severity code 7, 8, or 9 is encountered during the assembly of a user-written macro, and if an ALOG assembler control card is included in the input stream, a message (contained in the macro definition) will be immediately printed out on SYSLOG.

The format of the message is:

```
MNOTE SEV-n  xxxxxxxxxxxxxxxxxxxxxxxxxx  
              (text of message)
```

Input and Output Using an IBM 1442 or 2520 Card Read Punch. Whenever an IBM 1442 or 2520 Card Read Punch is assigned to SYSRDR and/or SYSIPT and also to SYSOPT, a number of blank cards sufficient for punching the output deck must follow the assembler source deck. If several jobs are assembled in succession (stacked jobs), enough cards must be inserted to prevent erroneously punching the cards of a following job. Any extra cards that are not needed are automatically bypassed.

Input On Magnetic Tape. When assembler input (the source program) is on magnetic tape, the tape must be positioned at the first data record before assembly begins. When input for several assemblies is on tape, separated by tape marks, the tape must be positioned at the first data record for each assembly. (The assembler program does not recognize or space over tape marks.) The FILES card can be used for this purpose.

Figure 32. Operating Considerations

LIBRARY PROGRAMS

The operating procedures for library programs are arranged, for the convenience of the operator, in eleven quick-reference sections:

- AORGZ Reallocate library limits program (Figure 35)
- CORGZ Copy system program (Figure 36)
- CSERV Core image library service program (Figures 37 and 38)
- DSERV Directory service program (Figures 39 and 40)
- LORGZ Condense library program (Figure 41)
- MMAINT Macro library maintenance program (Figure 42)
- MSERV Macro library service program (Figures 43 and 44)
- PSERV PUB table service program (Figures 45 and 46)
- RMAINT Relocatable library maintenance program (Figure 47)
- RSERV Relocatable library service program (Figures 48 and 49)
- SYSCMA Core image library maintenance program (Figure 50).

Figure 33 illustrates the input/output units used by library programs.

Operating Considerations

INFORMATION ENTRY: All cards having // and blank in the first three columns are considered to be control cards, and enter the system via SYSRDR. All other cards (or card-images) must enter the system via SYSIPT.

PUNCHED CARD OUTPUT: All service programs that provide punched card output (CSERV, MSERV, RSERV) have a special consideration whenever the same IBM 1442 or 2520 is assigned to SYSRDR and/or SYSIPT and also

see NL

to SYSOPT. If the PUNCH or DSPCH librarian control card is used, then a sufficient number of blank cards for punching must follow each request (to prevent erroneously punching into any following control cards). The service programs automatically bypass any extra blank cards that are not needed and look for the next legitimate librarian control card.

PRINTER CARRIAGE TAPE: For programs that provide for printed output, a carriage channel 12 punch should be used to indicate an overflow condition. If a channel 9 punch is used, a physical IOCS error message will result.

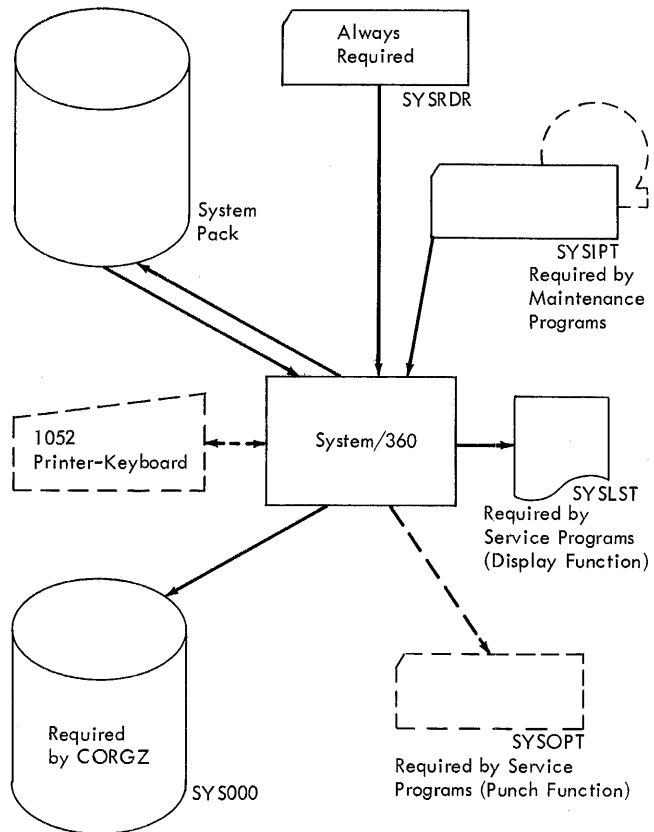

Figure 33. Input/Output Units Used by Library Programs

STATUS REPORT

When a printer is assigned to SYSLST, a status report (Figure 34) is printed for certain library programs. This report indicates the current condition of the system pack. A status report is printed at the successful completion of the following programs:

AORGZ	RMAINT
LORGZ	SYSCMA
MMAINT	Linkage Editor

In some cases, a status report can be printed if any of the following programs could not be successfully completed. It is printed as the result of a response to certain error messages. These programs are:

MMAINT	RSERV
MSERV	SYSCMA
RMAINT	Linkage Editor

The format of the status report is:

Title: program name SYSTEM DIRECTORY - CURRENT STATUS date

Heading line: item; starting address; current address; ending address; tracks and blocks allocated, active, deleted, available.

Eight body lines: one line for each allocatable item on the system pack. These are:

- Core image directory (CD)
- Core image library (CL)
- Macro directory (MD)
- Macro library (ML)
- Relocatable directory (RD)
- Relocatable library (RL)
- Volume area (label control card area) (VA)
- Checkpoint area. (CP)

PROGRAM NAME - SYSTEM DIRECTORY - CURRENT STATUS										DATE	
Item	Starting Addr in Hex	Current Addr in Hex	Ending Addr in Hex	Allocated		Active		Deleted		Available	
				Tracks	Blocks	Tracks	Blocks	Tracks	Blocks	Tracks	Blocks
	Note 1	Note 2	Note 3	Note 4		Note 5		Note 5		Note 5	
CD	7 bytes	8 bytes	8 bytes	6 digits	4 digits	No. of Entries		6 digits	4 digits	6 digits	4 digits
CL	7 bytes	7 bytes	7 bytes			6 digits	4 digits				
MD	7 bytes	8 bytes	8 bytes	6 digits	4 digits	No. of Entries		6 digits	4 digits	6 digits	4 digits
ML	7 bytes	7 bytes	7 bytes			6 digits	4 digits				
RD	7 bytes	8 bytes	8 bytes	6 digits	4 digits	No. of Entries		6 digits	4 digits	6 digits	4 digits
RL	7 bytes	7 bytes	7 bytes			6 digits	4 digits				
VA	7 bytes		7 bytes								
CP	7 bytes		7 bytes								

← IN HEX →
← IN DECIMAL →

Note 1. All items under starting ADDR in hex have the following format:

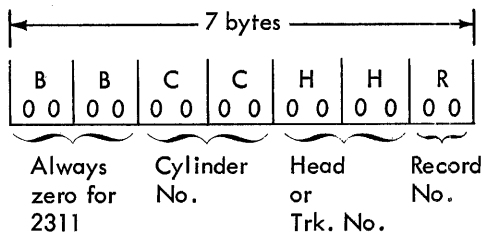

Example: 0002 000C 0009 0A means the 2nd disk pack, 12th cylinder, 9th track, and the 10th record.

Note 2: Items CD, MD, and RD under current ADDR in hex have the following format:

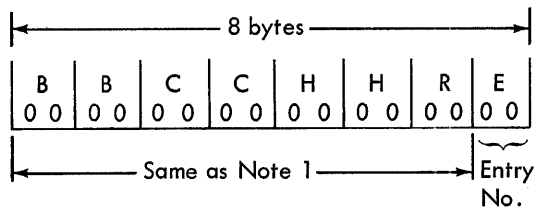

Items CL, ML, and RL have the same format as Note 1.

Note 3: Items CD, MD, and RD under ending ADDR in hex have the following format.

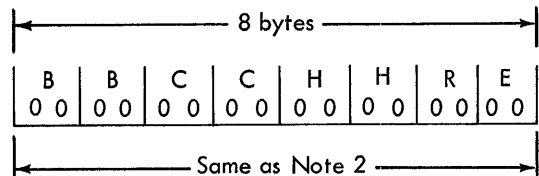

All other items have the same format as Note 1.

Note 4: Items CL, ML, and RL under allocated tracks and blocks have the following format:



Example: 000260 0001 means 260 tracks and 1 block have been allocated.

Note 5: Items CD, MD, and RD under active tracks and blocks have the following format:



Example: 0126 ENTRIES means 126 active entries have been made.

Items CL, ML, and RL under active tracks and blocks, deleted tracks and blocks, and available tracks and blocks have the same format as Note 4.

Figure 34. System Status Report Format

MAINT			SYSTEM DIRECTORY - CURRENT STATUS				***05/01/65***				
ITEM	STARTING ADR-X	CURRENT ADR-X	ENDING ADR-X	ALLOCATED TRACKS	BLOCKS	ACTIVE TRACKS	BLOCKS	DELETED TRACKS	BLOCKS	AVAILABLE TRACKS	BLOCKS
CD	00000000000601	000000000007010C	0000000000070518			0115	ENTRIES				
CL	00000000000801	00000008000304	00000012000104	000174	0000	000065	0003	000010	0000	000098	0001
MD	00000012000201	0000001200020112	000000120003081A			0018	ENTRIES				
ML	00000012000401	00000014000506	00000039000808	000395	0000	000021	0005	000000	0000	000373	0003
RD	00000039000901	0000003900090100	0000003A00001009			0000	ENTRIES				
RL	0000003A000101	0000003A000101	00000054000910	000269	0000	000000	0000	000000	0000	000269	0000
VA	00000055000001		00000055000900								
CP	00000056000001		00000057000900								

SYSCMA			SYSTEM DIRECTORY - CURRENT STATUS				***08/01/65***				
ITEM	STARTING ADR-X	CURRENT ADR-X	ENDING ADR-X	ALLOCATED TRACKS	BLOCKS	ACTIVE TRACKS	BLOCKS	DELETED TRACKS	BLOCKS	AVAILABLE TRACKS	BLOCKS
CD	00000000000601	000000000007010C	0000000000070518			0115	ENTRIES				
CL	00000000000801	00000008000304	00000012000104	000174	0000	000065	0003	000010	0000	000098	0001
MD	00000012000201	0000001200020100	000000120003081A			0000	ENTRIES				
ML	00000012000401	00000012000401	00000039000808	000395	0000	000000	0000	000000	0000	000395	0000
RD	00000039000901	0000003900090100	0000003A00001009			0000	ENTRIES				
RL	0000003A000101	0000003A000101	00000054000910	000269	0000	000000	0000	000000	0000	000269	0000
VA	00000055000001		00000055000900								
CP	00000056000001		00000057000900								

Figure 35. Sample System Status Report

AORGZ--REALLOCATE LIBRARY LIMITS PROGRAM

AORGZ is used to reallocate (redefine the limits of) the libraries, library directories, and the checkpoint and label control card areas.

Device Assignments		
Symbolic Unit	Function and Device	
SYSRDR	Input device for job-control and program-control cards. IBM 1442, 2520, or 2540 Card Read Punch, or 2501 Card Reader.	
SYSLST	Required only if a status report and diagnostics are desired. IBM 1403, 1404 (continuous forms only), or 1443 Printer.	
Cards Submitted		
Group	Card Arrangement	Comments
Job Control	<pre>// JOB AORGZ // ASSGN SYSRDR,.. // ASSGN SYSLST,.. // VOL SYSRES,SYSRES // DLAB // XTENT // EXEC</pre>	<p>Required to request the AORGZ program. Make only those device assignments that are not currently in effect.</p> <p>} Required to create the new label of the system residence area.</p>
Program Control	<pre>// TRCKS // END</pre>	Required to request specific reallocations.
<p>The DLAB control card is punched as follows:</p> <pre> // DLAB 'BOS 8K DISK (33 blanks) lssssss', // 0001,yyddd,yyddd,'0000000000000' ssssss = Volume Serial Number yyddd = Creation and Expiration Dates </pre> <p style="text-align: right;">Col.72 c</p> <p>The XTENT control card is punched as follows:</p> <pre> // XTENT 1,000,0000001,cccchhh,'ssssss',SYSRES </pre> <p>cccchhh = the highest address of the extent to be reserved for system residence. ssssss = the same volume serial number used in the DLAB card.</p>		
<p><u>Execution</u></p> <ol style="list-style-type: none"> 1. The system supervisor must be present in main storage. 2. In a stacked-job environment, the job-control and program-control card groups must be inserted in the input stream at SYSRDR. 3. If the system is in the wait state, the job-control and program-control card groups must be placed at SYSRDR, and processing must be initiated by external interruption. 4. If SYSLST has been assigned, a status report and appropriate diagnostic messages are printed. 5. Each library on the system pack is automatically condensed. 		

Figure 36. AORGZ

CORGZ--COPY SYSTEM PROGRAM

CORGZ is used to selectively or completely copy the resident system onto another disk pack.

Device Assignments		
Symbolic Unit	Function and Device	
SYSRDR	Input device for job control and program control cards. IBM 1442, 2520, or 2540 Card Read Punch, or 2501 Card Reader.	
SYSLST	Required only if additional diagnostic information is desired. IBM 1403, 1404 (continuous forms only), or 1443 Printer.	
SYS000	Device on which the new disk resident system is created. IBM 2311 Disk Storage Drive.	
Cards Submitted		
Group	Card Arrangement	Comments
Job Control	<pre>// JOB CORGZ // ASSGN SYSRDR,.. // ASSGN SYSLST,.. // ASSGN SYS000,.. // VOL SYS000,SYSRES // DLAB // XTENT // EXEC</pre>	<p>Required to request the CORGZ program. Make only those device assignments that are not currently in effect.</p> <p>Required to create the new label of the system residence area.</p>
Program Control	<pre>// TRCKS // COPYS // END</pre>	Required to specify the parts of the resident system to be copied.
<p>The DLAB control card is punched as follows: Col.72</p> <pre>// DLAB 'BOS 8K DISK (33 blanks) lssssss', 0001,yyddd,yyddd,'0000000000000' ssssss = Volume Serial Number yyddd = Creation and Expiration Dates</pre> <p style="text-align: right;">c</p>		
<p>The XTENT control card is punched as follows:</p> <pre>// XTENT 1,000,0000001,cccchhh,'ssssss',SYS000</pre> <p>cccchhh = the highest address of the extent to be reserved for system residence. ssssss = the same volume serial number used in the DLAB card.</p>		
<u>Execution</u>		
<ol style="list-style-type: none"> The disk pack on SYS000 must have been prepared by the Initialize Disk utility program. The system supervisor must be present in main storage. In a stacked job environment, the job control and program control card groups must be inserted in the input stream at SYSRDR. If the system is in the wait state, the job control and program control card groups must be placed at SYSRDR, and processing must be initiated by external interruption. If SYSLST has been assigned, additional diagnostic information is printed. The parts of the resident system specified by the program control cards are copied from the system pack to SYS000. Each library copied on SYS000 is automatically condensed. 		

Figure 37. CORGZ

CSERV--CORE IMAGE LIBRARY SERVICE PROGRAM

CSERV is used to:

- Printout a phase that exists in the core image library (display function).
- Punch cards which represent a phase in the core image library (punch function).

Device Assignments		
Symbolic Unit	Function and Device	
SYSRDR	Input device for job control and program control cards. IBM 1442, 2520, or 2540 Card Read Punch, or 2501 Card Reader.	
SYSLST	Required only if the display function is to be used. IBM 1403, 1404 (continuous forms only), or 1443 Printer. (CSERV assumes 56 lines per page.)	
SYSOPT	Required only if the punch function is to be used. IBM 1442, 2520, or 2540 Card Read Punch.	
Cards Submitted		
Group	Card Arrangement	Comments
Job Control	// JOB CSERV // ASSGN SYSRDR,... // ASSGN SYSLST,... // ASSGN SYSOPT,... // EXEC	Required to request the CSERV program. Make only those device assignments that are not currently in effect.
Program Control	// DSPLY // PUNCH // DSPCH // END	Required to display and/or punch specific core image library phases.
Execution		
<ol style="list-style-type: none"> 1. The system supervisor must be present in main storage. 2. In a stacked job environment, the job control and program control card groups must be inserted in the input stream at SYSRDR. 3. If the system is in the wait state, the job control and program control card groups must be placed at SYSRDR, and processing must be initiated by external interruption. 4. The information specified by the program control cards is printed and/or punched on the devices designated as SYSLST and SYSOPT. 		
Printed Output		
<p>Heading line contains: Phase name Disk address of the phase Number of blocks required to contain the phase Number of bytes in the last block Loading address Execute address</p> <p>Body lines contain: Main-storage address of the first byte in the line Four blanks Eight 4-byte groups of information, each separated by four blanks</p>		
Punched Output		
<p>An absolute card deck that contains: // CATAL (one CATAL card for each 40 phases) PHASE ESD TXT END ENTRY (one ENTRY card for each 40 phases) // END(last card outputted by CSERV)</p> <p>If the phase name is five characters or less, it appears in columns 73-77 followed by three characters used for sequencing. This is the identification sequence field.</p> <p>If the phase name is six characters, its first, third, fourth, fifth, and sixth characters appear in columns 73-77 followed by the sequencing characters. For example, SYSRST would appear as SSRST.</p> <p>This card deck can be used as input to the LDSYS, SYSCMA, and RMAINT program. It can also be used as input to the link-and-execute function (EXEC LOADER) if the CATAL and END cards are removed.</p>		

● Figure 38. CSERV

PHASE NAME	PHASE DISC	ADDR	BLOCKS	BYTES	LOAD ADDR	EXEC ADDR		
SAMPL	00000009000403		003	768	0000L008	0000L00A		
	bb	cc	hh	r				
001008	F1F005A0	D701A806	A80645F0	A6EAD502	A96CA7E2	4770A0E4	45F0A706	D504A7D8
001028	A7E54770	A08E45F0	A706D502	A7D8A7EE	4780A0A8	D501A7D8	A7F14780	A088D501
001048	A7D8A7F3	4780A0C0	D501A7C8	A7F64780	A0C8D501	A7D8A7FA	4780A0D0	D501A7D8
001068	A7FE4780	A0D89540	A7D84780	A12E4850	A7CC4E50	A7C4F317	A080A7C4	96F0A081
001088	0A02F3F3	F0F04040	19134740	A02247F0	A12ED503	A7D8A7EA	4770A0F0	45F0A5F4
0010A8	185F6C8B	0A01E2E8	E2C5D6D1	9180A806	4710A0FC	967CA806	47F0A12E	9640A806
0010C8	47F0A0DC	9620A806	47F0A0CC	9610A806	47F0A0DC	9608A806	47F0A0DC	9604A806
0010E8	9680A806	47F0A022	0A02F3F2	F0F0C140	47F0A000	0A02F3F2	F2F0C140	47F0A000
001108	4850A7CC	4E50A7C4	F317A112	A7C496F0	A1130A02	F3F3F0F0	C140947F	A80647F0
001128	A000A02	F3F6F1F0	C14041E0	00041BFE	07FF9140	A8064710	A15A9120	A8064710
001148	A2FE9110	A8064710	A3389108	A8064710	A4489104	A8064710	A4C647F0	A0009140
001168	A8074710	A1369640	A80745F0	A5F4185F	4688D20A	A87EA87D	D205A87E	A81845F0
001188	A5F4185F	461145F0	A5F418F7	6C114120	A7F64130	A7F64130	0003D706	9201A80D
0011A8	9201A80E	45F0A624	19669240	A9BCD26C	A98DA9BC	D201A9BD	20000700	45F0A646
0011C8	060C1A36	00001990	D20DA9C1	A984D20F	A9D2A992	D20FA9E3	A9A24810	AA564E10
0011E8	A7C4F347	AA02A7C4	96F0AA06	D206AA08	A83845F0	A5F419C8	6E119240	A9BCD26C
001208	A98DA9BC	41220002	D201A9BD	20000700	45F0A646	06001A4D	00001990	D20DA9C1
001228	A984D20D	A9D2A992	D20DA9E3	A9A04810	AA584E10	A7C4F347	A9F4A7C4	96F0A9F8
001248	D205A9FA	A8424810	AA5A4E10	A7C4F347	96F0AA06	96F0AA06	D205AA08	A8424810
001268	AA5C4E10	A7C4F347	AA10A7C4	96F0AA14	D205AA16	A8424810	AA5E4E10	A7C4F347
001288	AA1EA7C4	96F0AA22	D205AA24	A84245F0	A5F419C8	6E114122	00024310	A80E4111
0012A8	07014210	A80E4630	A1A09240	A9BCD26C	A98DA9BC	45F0A624	1966D201	A9BD2000
0012C8	45F0A646	07001A36	00001990	D20DA9C1	A984D20D	A9E3A992	45F0A5F4	19C86E11
0012E8	41220002	D201A9BD	2000D20D	A9C1A9A0	D20DA9E3	A9AE45F0	A5F419C8	6E1147F0
001308	A12E9120	A8074710	A13E9620	A80745F0	A5F4185F	4688D20A	A87EA87D	D208A87E
001328	A81245F0	A5F4185F	4611D706	A808A808	9204A80D	9201A80E	47F0A36E	9110A807
001348	471CA146	9610A807	D706A808	A8089206	A80D9201	A80E45F0	A5F4185F	4688D20A
001368	A87EA87D	D209A87E	A83145F0	A5F4185F	4111D209	A89AA899	D208A8A9	A8A8D204
001388	A89EA848	D204A8AC	A84845F0	A5F418A5	52114120	003445F0	A6241968	4150AA30
0013A8	4050A3D2	1B334140	00199240	A9BCD26C	A98DA9BC	4163AA2A	955C6000	4780A12E
0013C8	D5016000	A8534780	A428D205	A9C26000	45F0A646	05001A3C	00001990	D20DA9D0
001528	41400010	4040A964	41400005	4040A966	41400010	4040A968	45F0A5F4	185F4688
001548	45FCA5F4	185F4611	45F0A5F4	18A52E11	9240A98C	D26CA98D	A9BC4120	00344840
001568	A9621833	45F0A624	196C4163	AA2A955C	60004780	A12ED501	6000A853	4780A5D2
001588	4850A966	4450A584	D200A9C2	60001876	41550001	1A750700	4070A59E	45F0A646
0015A8	02001A36	00C01990	D20DA9D0	A984D201	A9587007	4870A958	4E70A7C4	F337A9E4
0015C8	A7C496F0	A9E745F0	A5F419C8	2E094620	A5D24570	A5E64A30	A9644640	A56645F0
0015E8	A69C1974	181447F0	A55A45F0	A5F4185F	46884120	003807F7	5050A96C	485F0000
001608	4050A786	435F00C2	4250A78B	435F0003	4250A784	0A0017C0	9180A786	4780A614

• Figure 39. CSERV Printed Output

DSERV--DIRECTORY SERVICE PROGRAM

DSERV is used to display the contents of the following directories: system, transient, core image, macro, relocatable.

Device Assignments		
Symbolic Unit	Function and Device	
SYSRDR	Input device for job control and program control cards. IBM 1442, 2520, or 2540 Card Read Punch, or 2501 Card Reader.	
SYSLST	Display device. IBM 1403, 1404 (continuous forms only), or 1443 Printer.	
Cards Submitted		
Group	Card Arrangement	Comments
Job Control	// JOB DSERV // ASSGN SYSRDR,.. // ASSGN SYSLST,.. // EXEC	Required to request the DSERV program. Make only those device assignments that are not currently in effect.
Program Control	// DSPLY // END	Required to specify the directories to be displayed.
<u>Execution</u>		
<ol style="list-style-type: none"> 1. The system supervisor must be present in main storage. 2. In a stacked job environment, the job control and program control card groups must be inserted in the input stream at SYSRDR. 3. If the system is in the wait state, the job control and program control card groups must be placed at SYSRDR, and processing must be initiated by external interruption. 4. The information specified by the program control cards is printed on the device assigned to SYSLST. 		
<u>Printed Output</u>		
Identification line contains: Directory name,		
Heading line contains: Field headings describing contents.		
Body lines contain: Directory contents. (In the core image library and the relocatable library, a temporary entry has an asterisk before the phase or module name.)		

●Figure 40. DSERV

SYSTEM DIRECTORY							
Item	Starting Addr	Current Addr	Ending Addr	Allocated	Active	Deleted	Available
	Note 1	Note 2	Note 3	Note 4	Note 5	Note 5	Note 5
CD	7 bytes	8 bytes	8 bytes		No. of entries		
CL	7 bytes	7 bytes	7 bytes	No. of blocks	No. of blocks	No. of blocks	No. of blocks
MD	7 bytes	8 bytes	8 bytes		No. of entries		
ML	7 bytes	7 bytes	7 bytes	No. of blocks	No. of blocks	No. of blocks	No. of blocks
RD	7 bytes	8 bytes	8 bytes		No. of entries		
RL	7 bytes	7 bytes	7 bytes	No. of blocks	No. of blocks	No. of blocks	
VA	7 bytes		7 bytes				
CP	7 bytes		7 bytes				

CD = Core Image Directory
 CL = Core Image Library
 MD = Macro Directory
 ML = Macro Library

RD = Relocatable Directory
 RL = Relocatable Library
 VA = Volume Area (label control card area)
 CP = Checkpoint Area

Note 1. All items under starting ADDR have the following format:

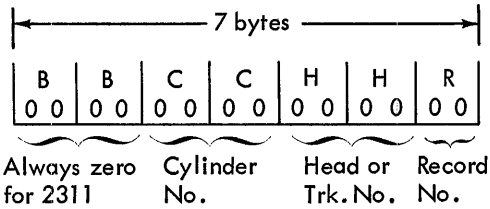

Example: 0002 000C 0009 0A means the 2nd disk pack, 12th cylinder, 9th track, and the 10th record.

Note 2. Items CD, MD, and RD under current ADDR have the following format:

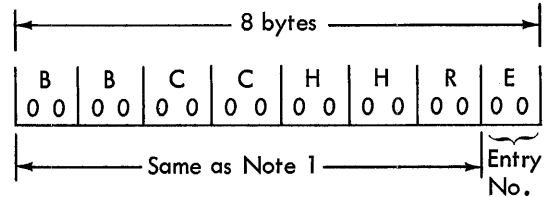

Items CL, ML, and RL have the same format as Note 1.

Note 3. Items CD, MD, and RD under ending ADDR have the following format:

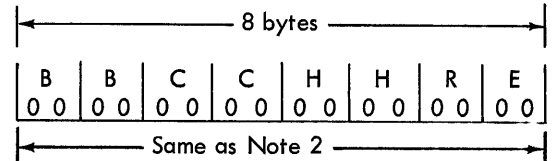

All other items have the same format as Note 1.

Note 4. Items CL, ML, and RL under allocated have the following format:

nnnnn BLOCKS
 No. in Decimal

Example: 02690 BLOCKS means 2,690 blocks have been allocated.

Note 5. Items CD, MD, and RD under active have the following format:

nnnnn ENTRIES
 No. in Decimal

Example: 00171 ENTRIES means 171 active entries have been made.

Items CL, ML, and RL under active, deleted, and available have the same format as Note 4.

Figure 41. System Directory Format

ITEM	STARTING ADDR	CURRENT ADDR	SYSTEM		DIRECTORY		
			ENDING ADDR	ALLOCATED	ACTIVE	DELETED	AVAILABLE
CD	00000000000601	00000000008020D	000000100030518		00171 ENTRIES		
CL	0000001000401	0000014000003	0000001C000904	01100 BLOCKS	00428 BLOCKS	00270 BLOCKS	00402 BLOCKS
MD	0000001C000901	0000001C00090512	0000001D0001081A		00126 ENTRIES		
ML	0000001D000201	00000032000606	00000042000108	02960 BLOCKS	01717 BLOCKS	00000 BLOCKS	01243 BLOCKS
RD	00000042000201	0000004200020604	0000004200051009		00052 ENTRIES		
RL	00000042000601	0000005B00060D	00000060000510	04800 BLOCKS	03944 BLOCKS	00068 BLOCKS	00788 BLOCKS
VA	00000060000601		00000061000500				
CP	00000061000601		00000063000500				

TRANSIENT DIRECTORY					
PHASE NAME	PHASE DISK ADDR	BLOCKS	BYTES	LOAD ADDR	EXEC ADDR
SYSSUP	00000008000002	005	00808	00000000	00001008
SYS DMP	00000008000103	001	00569	00000CE8	00000CEA
SYS CPT	00000008000104	001	00376	00000CE8	00000CEA
SYS RST	00000008000201	001	00400	00000CE8	00000CEA
SYS CPD	00000008000202	001	00653	00000CE8	00000CEA
SYS RSD	00000008000203	001	00428	00000CE8	00000CE8
SYS SEQJ	00000008000204	005	00415	00001008	0000100A
SYS BPD	00000008000401	001	00495	00001008	00001008
SYS STA	00000008000402	002	00152	00001008	00001008
SYS LDR	00000008000404	003	00144	00001008	00001488
SYS TXT	00000008000503	001	00320	000017F0	000017F0
SYS ESD	00000008000504	001	00384	000017F0	000017F0
SYS RLD	00000008000601	001	00472	000017F0	000017F0
SYS XFR	00000008000602	001	00064	000017F0	000017F0
SYS END	00000008000603	001	00072	000017F0	000017F0
SYS REP	00000008000604	001	00328	000017F0	000017F0
SYS CTL	00000008000701	001	00400	000017F0	000017F0
	00000008000702	001	00430	000017F0	000017F0

Disk address format:
bbcchhr

CORE IMAGE DIRECTORY					
PHASE NAME	PHASE DISK ADDR	BLOCKS	BYTES	LOAD ADDR	EXEC ADDR
SYSSUP	00000008000002	005	00808	00000000	00001008
SYS DMP	00000008000103	001	00569	00000CE8	00000CEA
SYS CPT	00000008000104	001	00376	00000CE8	00000CEA
SYS RST	00000008000201	001	00400	00000CE8	00000CEA
SYS CPD	00000008000202	001	00653	00000CE8	00000CEA
SYS RSD	00000008000203	001	00428	00000CE8	00000CE8
SYS SEQJ	00000008000204	005	00415	00001008	0000100A
SYS BPD	00000008000401	001	00495	00001008	00001008
SYS STA	00000008000402	002	00152	00001008	00001008
SYS LDR	00000008000404	003	00144	00001008	00001488
SYS TXT	00000008000503	001	00320	000017F0	000017F0
SYS ESD	00000008000504	001	00384	000017F0	000017F0
SYS RLD	00000008000601	001	00472	000017F0	000017F0

• Figure 42. DSERV Printed Output (1 of 2)

MACRO DIRECTORY		
MACRO NAME	MACRO DISK ADDR	BLOCKS
CCB	0000001D000201	0003
CHKPT	0000001D000204	0009
CHNG	0000001D000305	0003
CLOSE	0000001D000308	0019
CNTRL	0000001D000603	0011
COMRG	0000001D000706	0001
DTFBG	0000001D000707	0001
DTFEN	0000001D000708	0079
DTFPH	0000001E000707	0009
DUMP	0000001E000808	0001
EQJ	0000001E000901	0001
EXCP	0000001E000902	0001
EXIT	0000001E000903	0001
FETCH	0000001E000904	0001
IOCFG	0000001E000905	0097
JBCTI	00000020000106	0062

RELOCATABLE DIRECTORY		
MODULE NAME	MODULE DISK ADDR	BLOCKS
SYSOMP	00000042000801	0013
SYSRST	0000004200080E	0018
SYSRSD	00000042000910	0021
SYSOJ	00000043000105	0045
SYSSTA	00000043000402	0015
SYSLDR	00000043000501	0115
SYSMA	00000044000204	0021
MMAINT	00000044000309	0086
RMAINT	0000004400080F	0032
DSERV	0000004500000F	0028
CSERV	00000045000208	0025
MSERV	00000045000404	0039
LORGZ	0000004500080F	0026
AORGZ	00000046000009	0042
CORGZ	00000046000303	0071
SYSOAI	0000004600070A	0050

Figure 42. DSERV Printed Output (2 of 2)

LORGZ--CONDENSE LIBRARY PROGRAM

LORGZ is used to minimize the vacancies within a library by reorganizing it (Condense function).

Device Assignments		
Symbolic Unit	Function and Device	
SYSRDR	Input device for job-control and program-control cards. IBM 1442, 2520, or 2540 Card Read Punch, or 2501 Card Reader.	
SYSLST	Required only if a status report and diagnostics are desired. IBM 1403, 1404 (continuous forms only), or 1443 Printer.	
Cards Submitted		
Group	Card Arrangement	Comments
Job Control	// JOB LORGZ // ASSGN SYSRDR,.. // ASSGN SYSLST,.. // EXEC	Required to request the LORGZ program. Make only those device assignments that are not currently in effect.
Program Control	// CONDS // END	Required to specify libraries to be condensed.
<u>Execution</u>		
<ol style="list-style-type: none"> 1. The system supervisor must be present in main storage. 2. In a stacked-job environment, the job-control and program-control card groups must be inserted in the input stream at SYSRDR. 3. If the system is in the wait state, the job-control and program-control card groups must be placed at SYSRDR, and processing must be initiated by external interruption. 4. If SYSLST has been assigned, a status report and appropriate diagnostic messages are printed. 		

Figure 43. LORGZ

MMAINT--MACRO LIBRARY MAINTENANCE PROGRAM

MMAINT is used to:

- Add macros to the macro library (catalog function).
- Remove macros from the macro library (delete function).
- Change the name of a macro in the macro library (rename function).

Device Assignments		
Symbolic Unit	Function and Device	
SYSRDR	Input device for job-control and program-control cards. IBM 1442, 2520, or 2540 Card Read Punch, or 2501 Card Reader.	
SYSLST	Required only if a status report and diagnostics are desired. IBM 1403, 1404 (continuous forms only), or 1443 Printer.	
SYSIPT	Input device for macros. Required only for catalog function. IBM 1442, 2520, or 2540 Card Read Punch, 2501 Card Reader, or IBM 2400-series Magnetic Tape Unit (9-track, or 7-track with the data conversion feature). May be the same device as SYSRDR.	
Cards Submitted		
Group	Card Arrangement	Comments
Job Control	<pre>// JOB MMAINT // ASSGN SYSRDR,.. // ASSGN SYSLST,.. // ASSGN SYSIPT,.. // EXEC</pre>	Required to request the MMAINT program. Make only those device assignments that are not currently in effect.
Program Control	<pre>// CATAL // DELET // RENAM // END</pre>	Required to identify the function desired. Any number of CATAL, DELET, and RENAM cards may be used in a single job run.
Macro Input	<pre>MACRO control card Macro prototype Model statements Macro commands MEND statement</pre>	Required only for the catalog function.
<u>Execution</u>		
<ol style="list-style-type: none"> 1. The system supervisor must be present in main storage. 2. In a stacked-job environment, the job-control and program-control card groups must be inserted in the input stream at SYSRDR, and the macro input at SYSIPT (when using the catalog function). 3. If the system is in the wait state, the job-control and program-control card groups must be placed at SYSRDR, and the macro input at SYSIPT (when using the catalog function), and processing must be initiated by external interruption. 4. If SYSLST has been assigned, a status report and appropriate diagnostic messages are printed. 5. The macro is added to the macro library only if it is free of errors. 		
<u>Macro Processing Errors</u>		
When SYSLST is assigned, the diagnostic information printed is:		
3MEn macro-name (80-column printout of the card in error)		
n	<u>Meaning</u>	
1	Name field of statement is in error.	
2	Operation field of statement is in error.	
3	Operand of statement is in error.	
4	Violation of specifications for macro instructions.	
5.	A MACRO card has not been read.	

Figure 44. MMAINT

MSERV--MACRO LIBRARY SERVICE PROGRAM

MSERV is used to:

- Print a macro that exists in the macro library (display function).
- Punch a card deck that represents a macro in the macro library (punch function).

Device Assignments		
Symbolic Units	Function and Device	
SYSRDR	Input device for job-control and program-control cards. IBM 1442, 2520, or 2540 Card Read Punch, or 2501 Card Reader.	
SYSLST	Required if macros are to be displayed, or if a status report is to be printed for certain error conditions. IBM 1403, 1404 (continuous forms only), or 1443 Printer.	
SYSOPT	Required only if macro output in card form is desired. IBM 1442, 2520, or 2540 Card Read Punch.	
Cards Submitted		
Group	Card Arrangement	Comments
Job Control	// JOB MSERV // ASSGN SYSRDR,.. // ASSGN SYSLST,.. // ASSGN SYSOPT,.. // EXEC	Required to request the MSERV program. Make only those device assignments that are not currently in effect.
Program Control	// DSPLY // PUNCH // DSPCH // END	Required to display and/or punch specific macros.
<u>Execution</u>		
<ol style="list-style-type: none"> 1. The system supervisor must be present in main storage. 2. In a stacked-job environment, the job-control and program-control card groups must be inserted in the input stream at SYSRDR. 3. If the system is in the wait state, the job-control and program-control card groups must be placed at SYSRDR, and processing must be initiated by external interruption. 4. The macro information specified by the program-control cards is printed and/or punched on the devices designated as SYSLST and SYSOPT. 		
<u>Printed Output</u>		
First heading line contains: macro name name field of prototype (if used) macro sequence-identification number First body lines contain: parameters expressed in the prototype Second heading line contains: LABEL OPCODE OPERANDS COMMENTS Second body lines contain: contents of the macro macro sequence-identification number <u>Note:</u> All information is printed in EBCDIC, 56 lines/page.		
<u>Punched Output</u>		
The CATAL control card. The MACRO control card. Prototype with a macro sequence-identification number in columns 73-80. Body of macro with a macro sequence-identification number in columns 73-80. The MEND card (always the last card) with a macro sequence-identification number in columns 73-80.		

Figure 45. MSERV

MACRO LIBRARY -DISK-			
MACRO NAME - CCB	PROTOTYPE NAME - #NAME		CCB 001
PARAMETERS	#C01,#D01,#E01		
LABEL	OPCODE	OPERANDS AND COMMENTS	
.* IBM SYSTEM/360	-BASIC	OPERATING SYSTEM-BASIC CONTROL-360B-IO-302	CCB 002
.* CHANGE LEVEL 10			CCB 003
.* MACRO CCB			CCB 004
#NAME	DC	H000	CCB 005
	AIF	%0#E010 NE 000.OK	CCB 006
	DC	H000	CCB 007
	AGO	.OK2	CCB 008
.OK	ANOP		CCB 009
	DC	#E01 USER SPECIFIED INITIAL COMMUN	CCB 010
.OK2	ANOP		CCB 011
.* TEST FOR VALID FIRST PARAMETER			CCB 012
#CG1	SETC	@#C01@%1,30	CCB 013
	AIF	%0#CG10 EQ @SYS00.OK1	CCB 014
	AGO	.NO61	CCB 015
.OK1	ANOP		CCB 016
#CG2	SETC	@#C01@%4,30	CCB 017
	AIF	%0#CG20 NE @RES00.NO1	CCB 018
	DC	H0000 SYSRES	CCB 019
	AGO	.NO8	CCB 020
.NO1	AIF	%0#CG20 NE @RDR00.NO2	CCB 021
	DC	H0040 SYSRDR	CCB 022
	AGO	.NO8	CCB 023
.NO2	AIF	%0#CG20 NE @LST00.NO3	CCB 024
	DC	H0080 SYSLST	CCB 025
	AGO	.NO8	CCB 026
.NO3	AIF	%0#CG20 NE @IPT00.NO4	CCB 027
	DC	H0120 SYSIPT	CCB 028
	AGO	.NO8	CCB 029
.NO4	AIF	%0#CG20 NE @OPT00.NO5	CCB 030
	DC	H0160 SYSOPT	CCB 031
	AGO	.NO8	CCB 032
.NO5	AIF	%0#CG20 NE @LOG00.NO6	CCB 033
	DC	H0200 SYSLOG	CCB 034
	AGO	.NO8	CCB 035
.* TEST FOR INVALID ALPHANUMERIC			CCB 036
.NO6	AIF	%CG2 LT 2550.NO7	CCB 037
.NO61	MNOTE	@PARAMETER INCORRECTLY DEFINED@	CCB 038
	MNOTE	@ ASSUMED SYSLST@	CCB 039
	DC	H0080	CCB 040
	AGO	.NO8	CCB 041
.NO7	ANOP		CCB 042
#ALI	SETA	#CG2*4&24	CCB 043
	DC	H0#ALI0	CCB 044
.NO8	DC	Y#D010	CCB 045
	MEND		CCB 046

Figure 46. MSERV Printed Output

PSERV--PUB TABLE SERVICE PROGRAM

PSERV is used to:

- Change I/O device assignments in the supervisor on the system pack.
- Print out I/O device assignments from the supervisor on the system pack.
- Print out I/O device assignments from the supervisor in main storage.

Device Assignments		
Symbolic Unit	Function and Device	
SYSRDR	Input device for job-control and program-control cards. IBM 1442, 2520, or 2540 Card Read Punch, or 2501 Card Reader	
SYSLST	Required only if the display function is to be used. IBM 1403, 1404 (continuous forms only), or 1443 Printer.	
Cards Submitted		
Group	Card Arrangement	Comments
Job Control	// JOB PSERV // ASSGN SYSRDR,.. // ASSGN SYSLST,.. // EXEC	Required to request the PSERV program. Make only those device assignments that are not currently in effect.
Program Control	// ASSGN,.. // DSPLY {core}{All} // END {disk}	Used to change permanent assignments. Required to display assignments.
<u>Execution</u>		
<ol style="list-style-type: none"> 1. The system supervisor must be present in main storage. 2. In a stacked-job environment, the job-control and program-control card groups must be inserted in the input stream at SYSRDR. 3. If the system is in the wait state, the job-control and program-control card groups must be placed at SYSRDR, and processing must be initiated by external interruption. 4. The information specified on the DSPLY card will be printed on the device assigned to SYSLST. 		
<u>Printed Output</u>		
Heading line: FUNCTION CORRESPONDING ASSGN CARD DEVICE TYPE		
Body lines contain: Printout for each program-control ASSGN card or Printout of PUB table entry for each symbolic unit on the DSPLY card.		

Figure 47. PSERV

FUNCTION	CORRESPONDING ASSGN CARD	DEVICE TYPE
PRINT SYSRES FROM CORE	// ASSGN SYSRES,X@1C0@,D1,X@00@	2311 DISK DRIVE
PRINT SYSRDR FROM CORE	// ASSGN SYSRDR,X@008@,R1,X@00@	2540 CARD READER
PRINT SYSLST FROM CORE	// ASSGN SYSLST,X@012@,L1,X@00@	1403 OR 1404 PRINTER
PRINT SYSIPT FROM CORE	// ASSGN SYSIPT,X@008@,R1,X@00@	2540 CARD READER
PRINT SYSOPT FROM CURE	// ASSGN SYSOPT,X@180@,T1,X@90@	7 TRACK TAPE
	// ASSGN SYSOPT,X@180@,T2,X@00@	9 TRACK TAPE
PRINT SYSLOG FROM CORE	// ASSGN SYSLOG,X@01F@,C1,X@00@	1052 PRINTER-KEYBOARD
PRINT SYS000 FROM CORE	// ASSGN SYS000,X@1C0@,D1,X@00@	2311 DISK DRIVE
PRINT SYS001 FROM CORE	// ASSGN SYS001,X@181@,T1,X@90@	7 TRACK TAPE
	// ASSGN SYS001,X@181@,T2,X@00@	9 TRACK TAPE
PRINT SYS002 FROM CORE	// ASSGN SYS002,X@182@,T1,X@90@	7 TRACK TAPE
	// ASSGN SYS002,X@182@,T2,X@00@	9 TRACK TAPE

FUNCTION	CORRESPONDING ASSGN CARD	DEVICE TYPE
ASSIGN SYSLST ON DISK	// ASSGN SYSLST,X@00E@,L1,X@00@	1403 OR 1404 PRINTER
ASSIGN SYSLOG ON DISK	// ASSGN SYSLOG,X@009@,C1,X@00@	1052 PRINTER-KEYBOARD
ASSIGN SYS000 ON DISK	// ASSGN SYS000,X@1C0@,D1,X@00@	2311 DISK DRIVE

● Figure 48. PSERV Printed Output

RMAINT--RELOCATABLE LIBRARY MAINTENANCE PROGRAM

RMAINT is used to:

- Add modules to the relocatable library (catalog function).
- Delete modules from the relocatable library (delete function).
- Change the name of a module in the relocatable library (rename function).

Device Assignments		
Symbolic Unit	Function and Device	
SYSRDR	Input device for job-control and program-control cards. IBM 1442, 2520, or 2501 Card Reader.	
SYSIPT	Required only when using the catalog function. IBM 1442, 2520, or 2540 Card Read Punch, or 2501 Card Reader, or IBM 2400-series Magnetic Tape Unit (9-track, or 7-track with the data conversion feature). It must be positioned to the first data record. It may be the same card device as SYSRDR.	
SYSLST	Required only if diagnostics and status reports are desired. IBM 1403, 1404 (continuous forms only), or 1443 Printer.	
Cards Submitted		
Group	Card Arrangement	Comments
Job Control	// JOB RMAINT // ASSGN SYSRDR,.. // ASSGN SYSIPT,.. // ASSGN SYSLST,.. // EXEC	Required to request the RMAINT program. Make only those device assignments that are not currently in effect.
Program Control	// CATAL // DELET // RENAM // END	Required to specify functions and modules desired.
Module Input	ACTION INCLUDE PHASE SYM ESD TXT REP XFR RLD END ENTRY REND	These cards contain the data necessary for module building.
<u>Execution</u>		
<ol style="list-style-type: none"> 1. The system supervisor must be present in main storage. 2. In a stacked-job environment, the job-control and program-control card groups must be inserted in the input stream at SYSRDR, and the module input group at SYSIPT (when using the catalog function). 3. If the system is in the wait state, the job-control and program-control card groups must be placed at SYSRDR and the module input group at SYSIPT (when using the catalog function), and processing must be initiated by external interruption. 4. If SYSLST has been assigned, a status report and certain error messages will be printed. 		
<u>Special Error Messages</u>		
<p>These error messages printed on SYSLST contain information in addition to that available on the console or SYSLOG.</p> <p>3302 module-name (80 columns of RENAM card) 3405 module-name (80 columns of CATAL card) 3406 module-name (80 columns of CATAL card) 3501 module-name (80 columns of DELET or RENAM card).</p>		

Figure 49. RMAINT

RSERV--RELOCATABLE LIBRARY SERVICE PROGRAM

RSERV is used to:

- Print out a module that exists in the relocatable library (display function).
- Punch a card deck which represents a module in the relocatable library (punch function).

Device Assignments		
Symbolic Unit	Function and Device	
SYSRDR	Input device for job-control and program-control cards. IBM 1442, 2520, or 2540 Card Read Punch, or 2501 Card Reader.	
SYSLST	Required only for the display function. Used to print a status report when certain error conditions occur. IBM 1403, 1404 (continuous forms only), or 1443 Printer.	
SYSOPT	Required only for the punch function. IBM 1442, 2520, or 2540 Card Read Punch.	
Cards Submitted		
Group	Card Arrangement	Comments
Job Control	// JOB RSERV // ASSGN SYSRDR,.. // ASSGN SYSLST,.. // ASSGN SYSOPT,.. // EXEC	Required to request the RSERV program. Make only those device assignments that are not currently in effect.
Program Control	// DSPLY // PUNCH // DSPCH // END	Required to display and/or punch specific relocatable library modules.
<u>Execution</u>		
<ol style="list-style-type: none"> 1. The system supervisor must be present in main storage. 2. In a stacked-job environment, the job-control and program-control card groups must be inserted in the input stream at SYSRDR. 3. If the system is in the wait state, the job-control and program-control card groups must be placed at SYSRDR, and processing must be initiated by external interruption. 4. The information specified by the program-control cards is printed and/or punched on the devices designated as SYSLST and SYSOPT. 		
<u>Printed Output</u>		
<p>Heading line contains: Module name, number of blocks needed to contain the module, and the relocatable library address of the module.</p> <p>Statement list contains: All statements in the module.</p> <p>Information is printed 56 lines/page.</p>		
<u>Punched Output</u>		
<p>CATAL control card (first operand is module name)</p> <p>Statement cards (representing all statements in the module)</p> <p>ENTRY card (if last statement in module is ENTRY) or REND card (if last statement in module is not ENTRY).</p>		

Figure 50. RSERV

SYSCMA--CORE IMAGE LIBRARY MAINTENANCE PROGRAM

SYSCMA is used to:

- Add phases to the core image library (catalog function).
- Remove phases from the core image library (delete function).
- Change the names of phases in the core image library (rename function).

Device Assignments		
Symbolic Unit	Function and Device	
SYSRDR	Input device for job-control and program-control cards. IBM 1442, 2520, or 2540 Card Read Punch, or 2501 Card Reader.	
SYSIPT	Required only if CATAL card without an operand is used in the job, because CATAL module-name,R specifies only relocatable library input. IBM 1442, 2520, or 2540 Card Read Punch, or 2501 Card Reader, or IBM 2400-series Magnetic Tape Unit (9-track, or 7-track with the data conversion feature). It must be positioned to the first record. It may be the same device as SYSRDR.	
SYSLST	Required only if a status report and diagnostics are desired. IBM 1403, 1404 (continuous forms only), or 1443 Printer.	
Cards Submitted		
Group	Card Arrangement	Comments
Job Control	// JOB SYSCMA // ASSGN SYSRDR,.. // ASSGN SYSIPT,.. // ASSGN SYSLST,.. // EXEC	Required to request the SYSCMA program Make only those device assignments that are not currently in effect.
Program Control	// SPVSR // CATAL // DELET // RENAM // END	Required to specify functions desired. When the SPVSR card is used, it must be the first card of the group. The first maintenance function request must be a catalog of the new Supervisor.
Phase Input	ACTION INCLUDE PHASE SYM ESD TXT REP XFR RLD END ENTRY	Cards required to represent data used for building phases. This group is required in SYSIPT if a CATAL card without an operand is used in the job.
<u>Execution</u>		
<ol style="list-style-type: none"> 1. The system supervisor must be present in main storage. 2. In a stacked-job environment, the job-control and program-control card groups must be inserted in the input stream at SYSRDR, and the phase input card group at SYSIPT (when using the CATAL card with no operand). 3. If the system is in the wait state, the job-control and program-control card groups must be placed at SYSTRDR, and the phase input groups at SYSIPT (when using the CATAL card with no operand), and processing must be initiated by external interruption. 4. If SYSLST has been assigned, a status report and certain error messages will be printed. 5. Messages from the Linkage Editor are possible. 		

Figure 52. SYSCMA

SYSTEM GENERATION

The recommended steps for generating an installation-oriented disk-resident system from the IBM-supplied system pack are given in Figure 53. Figure 54 indicates the card input, both optional and required.

STEP	PROCEDURE	COMMENTS
1	Generate a copy (in cards, or on disk) of the IBM-supplied system pack.	See the section <u>Basic Operating System Backup</u> .
2	Assemble a new, installation-oriented Supervisor for the disk-resident system.	If the system Supervisor is not present in main storage, the operator must initiate an IPL from the system residence device. When the IPL operation is complete, the wait state is entered. The operator must then make the assignment for SYSRDR from the console.
3	Catalog the newly-created Supervisor into the core image library. Also, catalog key system programs and any other programs (from the relocatable library) that will be used in the future by the installation.	Use the SYSCMA program. Appendix E lists the names of the modules in the relocatable library of the IBM-supplied system pack.
4	Condense the core image library.	Use the LORGZ program.
5	Obtain backup of the new system pack (in cards or on another disk pack), if desired.	See the section <u>Basic Operating System Backup</u> .
6	Delete from the relocatable library any programs that are not desired for future use by the installation.	Use the RMAINT program. Appendix E lists the names of the modules in the relocatable library of the IBM-supplied system pack. (It may be desirable to delete everything in the relocatable library.)
7	Delete from the macro library any macros that are not desired for future use by the installation.	Use the MMAINT program. See Appendix E for the IBM-supplied macro names.
8	Condense or reallocate the relocatable library.	Use the LORGZ program to condense the library; Use the AORGZ program to reallocate the library.
System generation is now complete; the user may now add any user programs or macros to the libraries, as desired.		

Figure 53. System Generation

RELATED STEP	GROUP	CARD ARRANGEMENT	COMMENTS
1			See <u>Basic Operating System Backup</u> . The cards used depend on the number of disk drives used to obtain backup.
2	Job Control Cards	// JOB ASSEMBLER // DATE ... // ASSGN // VOL ... } // DLAB ... } // XTENT } // EXEC	Required. Required for first job after an IPL. Any device assignments necessary for the assembler (see <u>Assembler</u> section). Label cards required for SYS000. (Label cards for SYS001 are required if AWORK2 is specified.)
	Assembler Control Cards	SYSSUP AFILIB LIBRARY AOPTN .. } ALOG ... } AWORK .. }	Places the newly created Supervisor in the relocatable library; it is then ready for linkage editing. Optional.
	Supervisor Assembly Cards	SUPVR } SYMUN } IOCFG ... } SEND ... } END	Required to assemble the installation-oriented Supervisor. Assembler End Card.
3	Job Control Cards	// JOB SYSCMA // ASSGN // EXEC	Required to request the SYSCMA program. Any device assignments necessary for SYSCMA.
	Program Control Cards (continued)	// SPVSR // CATAL SYSSUP,R // CATAL SYSEOJ,R // CATAL SYSLDR,R // CATAL SYSCMA,R // CATAL SYSDMP,R // CATAL SYSSTA,R // CATAL SYSOAL,R // CATAL SYSOQA,R }	Required to catalog the newly-created supervisor and key system programs into the core image library.

Figure 54. Card Input for System Generation (Part 1 of 3)

RELATED STEP	GROUP	CARD ARRANGEMENT	COMMENTS
	Program Control Cards (continued)	<pre>// CATAL AORGZ,R // CATAL CORGZ,R // CATAL CSERV,R // CATAL DSERV,R // CATAL LORGZ,R // CATAL MMAINT,R // CATAL MSERV,R // CATAL PSERV,R // CATAL RMAINT,R // CATAL RSERV,R // CATAL SYSOJ1,R // CATAL SYSOLA,R // CATAL SYSOT0,R // CATAL SYSRSD,R // CATAL SYSRST,R // CATAL ASSEMB,R // CATAL ZZZ56A,R // END</pre>	<p>Optional.</p> <p>Required.</p>
4	Job Control	<pre>// JOB LORGZ // ASSGN // EXEC</pre>	<p>Required to request the LORGZ program.</p> <p>Any device assignments necessary for LORGZ.</p>
	Program Control	<pre>// CONDS CL // END</pre>	<p>Specifies that the core image library is to be condensed.</p> <p>Required.</p>
5			<p>See <u>Basic Operating System Backup</u>. The cards used depend on the number of disk drives used to obtain backup.</p>
6	Job Control	<pre>// JOB RMAINT // ASSGN // EXEC</pre>	<p>Required to request the RMAINT program.</p> <p>Any device assignments necessary for RMAINT.</p>
	Program Control	<pre>// DELET // END</pre>	<p>Used to delete any programs that are not desired for future use by the installation.</p> <p>Required.</p>
7	Job Control	<pre>// JOB MMAINT // ASSGN // EXEC</pre>	<p>Required to request the MMAINT program.</p> <p>Any device assignments necessary for MMAINT.</p>
	Program Control	<pre>// DELET // END</pre>	<p>Optional; used to delete any macros that are not desired for future use by the installation. See <u>Appendix E</u> for the names of IBM-supplied macros.</p> <p>Required.</p>

Figure 54. Card Input for System Generation (Part 2 of 3)

RELATED STEP	GROUP	CARD ARRANGEMENT	COMMENTS
8	Job Control	// JOB LORGZ // ASSGN ... // EXEC	To condense the relocatable library.
	Program Control	// CONDS RL // END or	
	Job Control	// JOB AORGZ // ASSGN ... // VOL SYSRES,SYSRES } // DLAB } // XTENT }	To reallocate the relocatable library Required to create the new label of the system residence area. (See Programmer's Guide, 8K Disk for contents.)
	Program Control	// EXEC // TRCKS // END	

Figure 54. Card Input for System Generation (Part 3 of 3)

BASIC OPERATING SYSTEM BACKUP

The resident system pack is necessary for operation of the 8K Disk Basic Operating System/360. Therefore, it is advisable to be prepared to continue system operation if the system pack becomes unusable. Procedures for obtaining this backup in cards or on another disk pack are shown in Figures 55 and 56. These procedures can be used for obtaining backup both before and after system generation is performed.

OBTAINING BOS BACKUP

- For a system with at least two 2311 Disk Drives.

STEP	PROCEDURE	COMMENTS
1	Use the Initialize Disk utility program to prepare a new disk pack.	See the operating guide for utility programs.
2	Using this pack and a system pack, execute the CORGZ program.	See the <u>CORGZ</u> section. (If CORGZ is in the relocatable library and not in the core image library, the EXEC card must be EXEC LOADER,R.)

Figure 55. Backup Procedure--Two Disk Drives

- For a system with only one 2311 Disk Drive.

STEP	PROCEDURE	COMMENTS
1	Mount the system pack on a 2311 Disk Drive. Ready this device.	
2	Place Job Control cards in the control card reader. Ready this device.	A DATE card must be included if this is the first job.
3	Dial the load-unit switches on the system control panel to the address (channel and unit) of the 2311.	
4	Press LOAD.	IPL and a Supervisor are loaded into main storage. The system enters the wait state.
5	If no device address has been specified for SYSRDR: Press STOP. Observe the WAIT light (must be on). Enter the device address in bytes 0, 1, and 2. Press START.	SYSRDR is the control card reader. <u>Byte 0--Channel Number</u> 00 for Multiplexor Channel 01 for Selector Channel 1 02 for Selector Channel 2 <u>Byte 1--Unit Number</u> 00 to FF depending on the device number <u>Byte 2--Device Type</u> 04 for 1442 Card Reader 08 for 2540 Card Reader 14 for 2501 Card Reader 16 for 2520 Card Reader
6	Press INTERRUPT.	Control is given to the Supervisor, which fetches the Job Control program. Job Control then reads control cards from SYSRDR. (SYSRDR should have control cards for punching the core image library.)
7	Execute CSERV to output the contents of the core image library.	See the <u>CSERV</u> section. (If CSERV is in the relocatable library and not in the core image library, the EXEC card must be EXEC LOADER,R.) The output of CSERV is a card deck (followed by a // END card), which is acceptable as input to the SYSCMA program.
8	Execute MSERV to output the contents of the macro library, if desired.	See the <u>MSERV</u> section. (If MSERV is in the relocatable library and not in the core image library, the EXEC card must be EXEC LOADER,R.) The output of MSERV is a card deck containing macros in a form acceptable as input to the MMAINT program.
9	Execute RSERV, if desired, to output the contents of the relocatable library.	See the <u>RSERV</u> section. (If RSERV is in the relocatable library and not in the core image library, the EXEC card must be EXEC LOADER,R.) The output of RSERV is a card deck containing modules in a form acceptable as input to the RMAINT program.
Card backup has now been obtained. Error messages are listed in the <u>Error Messages</u> section.		

Figure 56. Backup Procedure--One Disk Drive

Figure 57 is an example of cards submitted for a one-disk-drive system.

Card Arrangement	Comments
<pre>// JOB CSERV // ASSGN SYSOPT,... // EXEC // PUNCH ALL // END // PAUSE</pre>	<p>Calls CSERV program. Assigns a card punch to SYSOPT. Other assignments may be needed.</p> <p>Causes the entire core image library to be punched.</p> <p>Causes the wait state to be entered when CSERV is finished. The operator can then easily identify CSERV's output.</p>
<pre>// JOB MSERV // EXEC // PUNCH ALL // END // PAUSE</pre>	<p>Calls MSERV program.</p> <p>Causes the entire macro library to be punched.</p> <p>Causes the wait state to be entered. Used so the operator can easily identify the output of this job.</p>
<pre>// JOB RSERV // EXEC // PUNCH ALL // END // PAUSE</pre>	<p>Causes the entire relocatable library to be punched.</p> <p>Causes the wait state to be entered. Allows the operator time to identify the output of this job.</p>

Figure 57. Example--One Disk Drive

RECREATING A BASIC OPERATING SYSTEM FROM BACKUP

- For a system with at least two 2311 Disk Drives, (Figure 58).

STEP	PROCEDURE	COMMENTS
1	Use the Initialize Disk utility program to set up a new disk pack.	See the operating guide for utility programs.
2	Using this pack and the backup pack, copy the backup pack with the CORGZ program.	See the section on <u>CORGZ</u> for operating procedures.
3	Store one pack and use the other to generate a new BOS System pack, if necessary.	See the section on <u>System Generation</u> .

Figure 58. Recreation--Two Disk Drives

- For a system with only one 2311 Disk Drive, (Figure 57).

STEP	PROCEDURE	COMMENTS
1	Use the Initialize Disk utility program to prepare a new disk pack.	See the operating guide for utility programs.
2	Place these cards in a card reader. Card IPL routine Independent Supervisor Job Control Program // JOB LDSYS // ASSGN SYSLOG,... } optional // LOG // JOB LDSYS // ASSGN SYS000,X'cuu',D1 // DATE yyddd // EXEC LDSYS program // TRCKS lib,no,lib,no,.... lib can be DC,CL,MD,ML,RD, RL,VL,CP no is the number of tracks Disk IPL program // LOADC Core image library	These are part of the cards supplied by IBM with the initial distribution, of the BOS system pack. Job Control cards for the LDSYS program. These cards are punched by the user. Assigns a 1052 to SYSLOG. Causes the job control cards which follow to be logged. Calls the LDSYS program. Assigns a disk pack to be used for system residence. Starts execution of the LDSYS program. Supplied by IBM. Punched by the user. Allocates the number of tracks that each area on disk is to occupy. The core image directory, the core image library and the label control card area must be allocated. Supplied by IBM. (It is preceded by a // IPLDR card and followed by a // END card, which are also supplied with it.) Punched by the user. It supplies the core image library header. This is part of the card backup produced before initially generating a Basic Operating System. (Its last card is // END.)
3	IPL from the card reader.	After the independent supervisor and Job Control programs are loaded, LDSYS is loaded and executed. The new system pack now has an IPL routine and a core image library; the wait state is entered.
4	IPL from the new system disk pack.	See the section <u>Starting System Operation</u> . The Supervisor and Job Control are loaded.
5	Execute MMAINT, using the macro library backup as input.	See the MMAINT section. Job Control cards, including a PAUSE card, are punched by the user. A // END card must be placed following the MMAINT input.
6	Execute RMAINT, using the relocatable library backup as input.	See the RMAINT section. Job Control cards, including a PAUSE card, are punched by the user. A // END card must be placed following the RMAINT input.
The system pack is now complete.		

Figure 59. Recreation--One Disk Drive

PART 3: CARD FORMATS

JOB CONTROL CARDS

Identifier (cols. 1-2)	One or More Blanks	Operation	One or More Blanks	Operand or parameters (may not exceed col. 71)
//		JOB		program-name (only six characters are processed) ASSEMBLER,program-name
//		ASSGN		SYSxxx,X'cuu',dd,X'ss' or SYSxxx,UA
//		ASSGN		SYSxxx, col. 72 c
		<u>Continuation Card</u> (Columns 1 to 15 are blank.)		col. 16 X'cuu',dd,X'ss' or col. 16-17 UA
<p>UA = Unassign (to unassign an I/O device from a symbol unit).</p> <p>xxx = RDR for a Card Reader LST for a Printer IPT for an Input Unit OPT for an Output Unit LOG for a Control-Card Logging Device 000 to 254 for any Unit</p> <p>X'cuu' = Channel and Unit Number (in hexadecimal) c = 0 for a Multiplexor Channel 1 for Selector Channel 1 2 for Selector Channel 2 uu = 00 to FF (0 to 255) dd = Device-Type C1 - 1052 Printer-Keyboard D1 - 2311 Disk Drive L1 - 1403 or 1404 Printer L2 - 1443 or 1445 Printer P1 - 2540 Card Read Punch (punching only) P2 - 1442 Card Read Punch (punching only) P3 - 2520 Card Read Punch (punching only) R0 - 2671 Paper Tape Reader R1 - 2540 Card Read Punch R2 - 2540 Using Punch Feed Read Feature R3 - 1442 Card Read Punch (reading or reading and punching) R4 - 2501 Card Reader R5 - 2520 Card Read Punch (reading or reading and punching for combined files) RR - 1285 Optical Reader T1 - 2400 7-track Tape T2 - 2400 9-track Tape</p> <p>X'ss' = Device Specifications (required for certain I/O devices)</p>				

• Figure 60. Format of Job Control Cards (Part 1 of 5)

Identifier (cols. 1-2)	One or More Blanks	Operation	One or More Blanks	Operand or parameters (may not exceed col. 71)																																																																																										
The specifications for 7-track tape are:																																																																																														
<table border="1" style="margin-left: auto; margin-right: auto;"> <thead> <tr> <th>Density (Bytes per Inch)</th> <th>Parity</th> <th>Convert Feature</th> <th>Translate</th> <th>ss</th> </tr> </thead> <tbody> <tr><td>200</td><td>odd</td><td>on</td><td>off</td><td>10</td></tr> <tr><td>200</td><td>odd</td><td>off</td><td>off</td><td>30</td></tr> <tr><td>200</td><td>odd</td><td>off</td><td>on</td><td>38</td></tr> <tr><td>200</td><td>even</td><td>off</td><td>off</td><td>20</td></tr> <tr><td>200</td><td>even</td><td>off</td><td>on</td><td>28</td></tr> <tr><td colspan="5" style="text-align: center;">-----</td></tr> <tr><td>556</td><td>odd</td><td>on</td><td>off</td><td>50</td></tr> <tr><td>556</td><td>odd</td><td>off</td><td>off</td><td>70</td></tr> <tr><td>556</td><td>odd</td><td>off</td><td>on</td><td>78</td></tr> <tr><td>556</td><td>even</td><td>off</td><td>off</td><td>60</td></tr> <tr><td>556</td><td>even</td><td>off</td><td>on</td><td>68</td></tr> <tr><td colspan="5" style="text-align: center;">-----</td></tr> <tr><td>800</td><td>odd</td><td>on</td><td>off</td><td>90</td></tr> <tr><td>800</td><td>odd</td><td>off</td><td>off</td><td>B0</td></tr> <tr><td>800</td><td>odd</td><td>off</td><td>on</td><td>B8</td></tr> <tr><td>800</td><td>even</td><td>off</td><td>off</td><td>A0</td></tr> <tr><td>800</td><td>even</td><td>off</td><td>on</td><td>A8</td></tr> </tbody> </table>					Density (Bytes per Inch)	Parity	Convert Feature	Translate	ss	200	odd	on	off	10	200	odd	off	off	30	200	odd	off	on	38	200	even	off	off	20	200	even	off	on	28	-----					556	odd	on	off	50	556	odd	off	off	70	556	odd	off	on	78	556	even	off	off	60	556	even	off	on	68	-----					800	odd	on	off	90	800	odd	off	off	B0	800	odd	off	on	B8	800	even	off	off	A0	800	even	off	on	A8
Density (Bytes per Inch)	Parity	Convert Feature	Translate	ss																																																																																										
200	odd	on	off	10																																																																																										
200	odd	off	off	30																																																																																										
200	odd	off	on	38																																																																																										
200	even	off	off	20																																																																																										
200	even	off	on	28																																																																																										

556	odd	on	off	50																																																																																										
556	odd	off	off	70																																																																																										
556	odd	off	on	78																																																																																										
556	even	off	off	60																																																																																										
556	even	off	on	68																																																																																										

800	odd	on	off	90																																																																																										
800	odd	off	off	B0																																																																																										
800	odd	off	on	B8																																																																																										
800	even	off	off	A0																																																																																										
800	even	off	on	A8																																																																																										
The specifications for a 1403 printer with the UCS (Universal Character Set) special feature are:																																																																																														
<table border="1" style="margin-left: auto; margin-right: auto;"> <thead> <tr> <th>ss</th> <th>Meaning</th> </tr> </thead> <tbody> <tr> <td>73</td> <td>ignore any data check</td> </tr> <tr> <td>7B</td> <td>accept any data check</td> </tr> </tbody> </table>					ss	Meaning	73	ignore any data check	7B	accept any data check																																																																																				
ss	Meaning																																																																																													
73	ignore any data check																																																																																													
7B	accept any data check																																																																																													
<p>If either of these commands is issued to a printer without the UCS feature, a command reject occurs and the system enters the wait state.</p> <p>To use this feature of the ASSGN card, the 2821 control unit must be updated through Engineering Change #125632 or Request for Engineering Action #0100037.</p> <p>c = Continuation punch (any nonblank character)</p>																																																																																														
//		FILES		SYSxxx,n xxx = Symbolic designation of the tape file. Can be IPT, OPT, 000 to 254. n = the number of tape marks to be skipped (from present position). It is a minimum of four characters (1-9999).																																																																																										
//		VOL		SYSxxx,ffffff xxx = Symbolic designation of the tape or disk file. IPT for an Input Unit OPT for an Output Unit 000 to 254 for any Unit fffffff = file name (1 to 7 characters)																																																																																										

●Figure 60. Format of Job Control Cards (Part 2 of 5)

Identifier (cols. 1-2)	One or More Blanks	Operation	One or More Blanks	Operand or parameters (may not exceed col. 71)																																				
//		TPLAB		'label fields'																																				
//		TPLAB		'label fields' col. 72 c																																				
		Continuation Card (optional) col. 16 (Columns 1 to 15 are blank.) remaining label information'																																						
		' = an apostrophe (5-8 punch). It is the first character in the operand of the TPLAB card. It is also the last character in either the TPLAB card or the continuation card, indicating the end of label information.																																						
		c = Continuation punch (any nonblank character is allowed). It is punched in column 72 of the TPLAB card if a continuation card is used.																																						
		<table border="1"> <thead> <tr> <th>Field No.</th> <th>Field Size</th> <th>Field Name</th> </tr> </thead> <tbody> <tr><td>3</td><td>17</td><td>File Identifier</td></tr> <tr><td>4</td><td>6</td><td>File Serial Number</td></tr> <tr><td>5</td><td>4</td><td>Volume Sequence Number</td></tr> <tr><td>6</td><td>4</td><td>File Sequence Number</td></tr> <tr><td>7</td><td>4</td><td>Generation Number</td></tr> <tr><td>8</td><td>2</td><td>Version Number of Generation</td></tr> <tr><td>9</td><td>6</td><td>Creation Date</td></tr> <tr><td>10</td><td>6</td><td>Expiration Date</td></tr> <tr><td>11</td><td>1</td><td>File Security</td></tr> <tr><td>12</td><td>6</td><td>Block Count (leave blank)</td></tr> <tr><td>13</td><td>13</td><td>System Code</td></tr> </tbody> </table>			Field No.	Field Size	Field Name	3	17	File Identifier	4	6	File Serial Number	5	4	Volume Sequence Number	6	4	File Sequence Number	7	4	Generation Number	8	2	Version Number of Generation	9	6	Creation Date	10	6	Expiration Date	11	1	File Security	12	6	Block Count (leave blank)	13	13	System Code
Field No.	Field Size	Field Name																																						
3	17	File Identifier																																						
4	6	File Serial Number																																						
5	4	Volume Sequence Number																																						
6	4	File Sequence Number																																						
7	4	Generation Number																																						
8	2	Version Number of Generation																																						
9	6	Creation Date																																						
10	6	Expiration Date																																						
11	1	File Security																																						
12	6	Block Count (leave blank)																																						
13	13	System Code																																						
Note:	If this card is for an input file, an apostrophe can be placed after Field 10 to indicate that no more information follows.																																							
//		DLAB		'label fields 1-3', col. 72 c																																				
		Continuation Card col. 16 (Columns 1 to 15 are blank.) label fields 4,5,6,'label field 8'																																						
		' = an apostrophe																																						
		c = Continuation punch (any nonblank character is allowed). It is punched in column 72 of the DLAB card.																																						
		<table border="1"> <thead> <tr> <th>Field No.</th> <th>Field Size</th> <th>Field Name</th> </tr> </thead> <tbody> <tr><td>1</td><td>44</td><td>File Name</td></tr> <tr><td>2</td><td>1</td><td>Format Identifier</td></tr> <tr><td>3</td><td>6</td><td>File Serial Number</td></tr> <tr><td>4</td><td>4</td><td>Volume Sequence Number</td></tr> <tr><td>5</td><td>5</td><td>Creation Date</td></tr> <tr><td>6</td><td>5</td><td>Expiration Date</td></tr> <tr><td>8</td><td>13</td><td>System Code</td></tr> </tbody> </table>			Field No.	Field Size	Field Name	1	44	File Name	2	1	Format Identifier	3	6	File Serial Number	4	4	Volume Sequence Number	5	5	Creation Date	6	5	Expiration Date	8	13	System Code												
Field No.	Field Size	Field Name																																						
1	44	File Name																																						
2	1	Format Identifier																																						
3	6	File Serial Number																																						
4	4	Volume Sequence Number																																						
5	5	Creation Date																																						
6	5	Expiration Date																																						
8	13	System Code																																						

● Figure 60. Format of Job Control Cards (Part 3 of 5)

Identifier (cols. 1-2)	One or More Blanks	Operation	One or More Blanks	Operand or parameters (may not exceed col. 71)
//		XTENT		<p>type,sequence,lower,upper,'serial no.',SYSxxx</p> <p>type--<u>Extent Type</u>. It can be:</p> <p>1 for data area 2 for overflow area (for indexed sequential file) 4 for index area (for indexed sequential file)</p> <p>sequence--<u>Extent Sequence Number</u>. It can be:</p> <p>000 to 255 (indicates the sequence number of this extent within a multi-extent file)</p> <p><u>Note</u>: Extent sequence numbers for all files begin with 000 except for indexed sequential files that <u>do not</u> have a Master Index. In this case the first extent sequence number is 001 (for the cylinder index).</p> <p>lower--<u>Lower Limit of Extent</u>. It has the form cccchhh:</p> <p>cccc = 0000 to 0202 (cylinder number) hhh = 000 to 009 (head number)</p> <p><u>Note</u>: A lower limit of 0000000 is not permitted.</p> <p>upper--<u>Upper Limit of Extent</u>. It has the form cccchhh:</p> <p>cccc = 0000 to 0202 (cylinder number) hhh = 000 to 009 (head number)</p> <p>'serial no.'--<u>Volume Serial Number</u>. It is six alphameric characters, punched within apostrophes (8-5 punch). It is the same as the volume serial number in the volume label and the file serial number in the Format 1 label.</p> <p>SYSxxx--<u>Symbolic Unit</u>.</p> <p>xxx = IPT for an Input Unit OPT for an Output Unit 000 to 254 for any Unit</p>
//		DATE		<p>yyddd</p> <p>yy = Year (two digits)</p> <p>ddd = Day of the Year (three digits)</p>
//		UPSI		<p>nnnnnnnn</p> <p>n = 0 if the switch is Off.</p> <p>n = 1 if the switch is On.</p> <p>If a 1 is not specified, a zero is assumed.</p>

Figure 60. Format of Job Control Cards (Part 4 of 5)

LINKAGE EDITOR INPUT CARDS

Columns	Contents
ACTION Card (punched by the user)	
73-80	<p>One or more blanks</p> <p>ACTION</p> <p>One or more blanks</p> <p>MAP, NOMAP, or CLEAR</p> <p>Blanks</p> <p>Ignored - may be used for program identification.</p>
END Card (Assembler output)	
1	Multiple punch (12-2-9).
2-4	END
6-8	Assembled origin of the label supplied to the assembler in the END card (optional).
15-16	ESID number of the control section to which this END card refers.
17-22	Symbolic label supplied to the assembler if this label was not defined within the assembly.
73-80	Ignored - may be used for program identification.
ENTRY Card (punched by the user)	
73-80	<p>One or more blanks</p> <p>ENTRY</p> <p>One or more blanks</p> <p>Entry point - symbolic name of an entry point. This parameter is optional. If used, it must be a symbol defined in the program with the assembler ENTRY statement, or it must be the name of a START or CSECT statement. It must be followed by at least one blank.</p> <p>Ignored - may be used for program identification.</p>
ESD Card (Assembler output)	
1	Multiple punch (12-2-9)
2-4	ESD
11-12	Number of bytes of information contained in this card.
15-16	External symbol identification number (ESID) of the first SD, PC, or ER on this card.
17-72	<p>Variable information:</p> <p>8 positions Name</p> <p>1 position Type code to indicate SD, PC, LD, or ER.</p> <p>3 positions Assembled origin.</p> <p>1 position Blank</p> <p>3 positions Control-section length if an SD-type or a PC-type.</p> <p>External symbol identification (ESID) number of the SD or PC containing the label if this is an LD-type.</p>
73-80	Ignored - may be used for program identification.

Figure 61. Linkage Editor Input Cards (Part 1 of 4)

Columns	Contents
INCLUDE Card (punched by user)	
	<p>One or more blanks</p> <p>INCLUDE</p> <p>One or more blanks</p> <p>module-name</p> <p>Ignored</p>
PHASE Card (punched by user)	
	<p>One or more blanks</p> <p>PHASE</p> <p>One or more blanks</p> <p>Variable information:</p> <p>xxxxxx Symbolic name of the phase. 1 to 6 characters allowed. If more than six appear, only the first six will be used.</p> <p>f-flag Indicates the origin point for loading the phase. (The main storage loading address is relative to this point) S = Address of the last location of the Supervisor. C = Address of the last location of main storage L = A symbolic label defined in a previous phase. A = Absolute address.</p> <p>nnnnnn Displacement. Allows the origin point (loading address) to be modified by a set amount. A positive displacement has no sign and is allowed to be 1 to 6 decimal digits. If the displacement is negative, a minus sign (-) pre- cedes 1-5 decimal digits. A plus sign (+) preceding the displacement is an error.</p> <p>ssssssss Symbolic label. May be 1 to 8 characters. It is prede- fined by having appeared in a previous phase. When in- cluded, it allows this phase to origin at the address the label represents. The symbolic label must be the name of a START or CSECT statement, or the operand of an assembler ENTRY statement.</p>
REP Card (punched by user)	
1	Multiple punch (12-2-9).
2-4	REP
5-6	Blank
7-12	Assembled address of the first byte to be replaced (hexadecimal).
13	Blank
14-16	External symbol identification number (ESID) of the control section (SD) containing the text.
17-72	From 1 to 11 four-digit hexadecimal fields separated by commas, each replacing one previously loaded halfword. A blank indicates the end of information in this card.
73-80	May be used for program identification.

Figure 61. Linkage Editor Input Cards (Part 2 of 4)

Columns	Contents
RLD Card (Assembler output)	
1	Multiple punch (12-2-9).
2-4	RLD
11-12	Number of bytes of information contained in the card.
17-72	Variable information. (Multiple items.)
	2 positions. Pointer to the relocation factor of the contents of the load constant.
	2 positions. Pointer to the relocation factor of the control sections in which the load constant occurs.
	1 position. Flag indicating type of constant.
	3 positions. Assembled address of load constant.
73-80	May be used for program identification.
TXT Card (Assembler output)	
1	Multiple punch (12-2-9).
2-4	TXT
6-8	Assembled origin (address of first byte to be loaded from this card).
11-12	Number of bytes of text to be loaded.
15-16	External symbol identification number (ESID) of the control section (SD) containing the text.
17-72	Up to 56 bytes of text (data or instructions to be loaded).
73-80	May be used for program identification.
XFR Card (Assembler output)	
1	Multiple punch (12-2-9).
2-4	XFR
6-8	Assembled origin of entry point (after the program is loaded, it receives control at this point).
15-16	ESID number of the control section to which this XFR card refers.
17-22	Symbolic label supplied to the assembler if this label was not defined within the assembly.
73-80	May be used for program identification.

Figure 61. Linkage Editor Input Cards (Part 3 of 4)

SYM Card (Assembler Output) Note: Punched only if AOPTN PCHSYM is specified.)

1 Multiple punch (12-2-9)

2-4 SYM

11-12 Number of bytes of information contained in this card.

14-16 ESD - ID

17-72 Variable information

ID is EQU, DC, or DS:

1 position - type ID

3 positions - value attribute (displacement within CSECT)

8 positions - symbol name

1 position - constant type

1 position - length (one less than constant)

3 positions - multiplicity

ID is machine or assembler instruction other than EQU, DC, or DS:

1 position - type ID

3 positions - value attribute (displacement within CSECT)

8 positions - symbol name

Program identification taken from the name field of the first TITLE statement before the START card.

Sequence number starting with 0001.

Figure 61. Linkage Editor Input Cards (Part 4 of 4)

LIBRARIAN PROGRAM CONTROL CARDS

Identifier (cols.1-2)	One or More Blanks	Operation	One or More Blanks	Operand (may not exceed column 71)	Program(s) That Use This Card
//		CATAL		(Operand is blank; input is in SYSIPT)	MMAINT SYSCMA
//		CATAL		module-name (specified module is in SYSIPT)	RMAINT
//		CATAL		module-name,R (specified module in the relocatable library)	SYSCMA
//		CONDS		ALL	LORGZ
//		CONDS		id,id,id <u>Note:</u> One, two, or three library identifiers may appear in this card.	LORGZ
				<u>id</u> = library identifier. It can be: CL for the core image library. ML for the macro library. RL for the relocatable library.	
//		COPYS		ALL	CORGZ
//		COPYS		id,ALL	CORGZ
//		COPYS		id,name1,name2,.....,name-n (this form may have a continuation card; columns 1-15 must be blank; information starts in column 16) <u>Note:</u> ALL must not be continued in a succeeding card.	col. 72 c CORGZ
				<u>id</u> = library identifier. It can be: CL for the core image library. ML for the macro library. RL for the relocatable library.	
				name1,name2,....,name-n = the names of phases, macros, or modules to be copied.	
				c = continuation punch (any nonblank character)	
//		DELET		ALL	MMAINT RMAINT
//		DELET		phase-name	SYSCMA
//		DELET		macro-name	MMAINT
//		DELET		module-name	RMAINT

Figure 62. Program Control Cards (Part 1 of 3)

Identifier (cols.1-2)	One or More Blanks	Operation	One or More Blanks	Operand (may not exceed column 71)	Program(s) That Use This Card
//		DSPCH		ALL	CSERV MSERV RSERV
//		DSPCH		phase-name,phase-name,....,phase-name	CSERV
//		DSPCH		macro-name,macro-name,....,macro-name	MSERV
//		DSPCH		module-name,module-name,...,module-name	RSERV
//		DSPLY		ALL	CSERV DSERV MSERV RSERV
//		DSPLY		CORE,ALL or CORE,SYSxxx,SYSxxx.....	PSERV
//		DSPLY		DISK,ALL or DISK,SYSxxx,SYSxxx.....	PSERV
//		DSPLY		phase-name,phase-name,....,phase-name	CSERV
//		DSPLY		macro-name,macro-name,....,macro-name	MSERV
//		DSPLY		module-name,module-name,...,module-name	RSERV
//		DSPLY		id,id,id,id,id id = directory identifiers. It can be: CD = core image directory MD = macro directory RD = relocatable directory SD = system directory TD = transient directory	DSERV
//		END		(Operand is blank)	AORGZ CORGZ CSERV DSERV LORGZ MMAINT MSERV PSERV RMAINT RSERV SYSCMA
//		PUNCH		ALL	CSERV MSERV RSERV
//		PUNCH		phase-name,phase-name,....,phase-name	CSERV
//		PUNCH		macro-name,macro-name,....,macro-name	MSERV
//		PUNCH		module-name,module-name,....,module-name	RSERV

Figure 62. Program Control Cards (Part 2 of 3)

Identifier (cols. 1-2)	One or More Blanks	Operation	One or More Blanks Operand (may not exceed column 71)	Program(s) That Use This Card
//		RENAM	current-macro-name,new-macro-name	MMAINT
//		RENAM	current-module-name,new-module-name	RMAINT
//		RENAM	current-phase-name,new-phase-name	SYSCMA
//		SPVSR	(Operand is blank)	SYSCMA
//		TRCKS	id,no,id,no,id,no..... <u>id</u> = identifier. It can be: CD for the core image directory (required for CORGZ). CL for the core image library (required for CORGZ). CP for the checkpoint area. MD for the macro directory. ML for the macro library. RD for the relocatable directory. RL for the relocatable library. VL for the volume (label control card) area (required for CORGZ). <u>no</u> = the number of tracks to be allocated. It can be any integer.	AORGZ CORGZ

Figure 62. Program Control Cards (Part 3 of 3)

APPENDIX A: EXTENDED BINARY CODED DECIMAL INTERCHANGE CODE (EBCDIC)

The following charts (in Figure 63) show the bit configurations of the 256 possible codes (characters) of the Extended BCD Interchange Code. To write a given character in binary, locate the character on the chart. The top row of coordinates equates to bit positions 0 and 1, the second row to bit positions 2 and 3, and the left row of coordinates equates to bit positions 4, 5, 6 and 7.

Examples:

Character A equals:

top row - 11 (bit positions 0, 1)
2nd row - 00 (bit positions 2, 3)
left row - 0001 (bit positions 4, 5,
6 and 7)

Therefore, character A is shown as:
1100 0001.

Character \$ equals:

top row - 01 (bit positions 0, 1)
2nd row - 01 (bit positions 2, 3)
left row - 1011 (bit positions 4, 5,
6 and 7)

Therefore, character \$ is shown as:
0101 1011.

The coordinates on the bottom of the chart are the three zone punches required to reproduce the character in a punched card; the coordinates on the right side represent the numeric punches.

Examples:

Character A = bottom row - 12 punch
right row - 1 punch

Therefore, Character A is shown by a 12 and a 1 punch in the same card column.

Character \$ = bottom row - 11 punch
right row - 8 and 3 punches

Therefore, Character \$ is shown by 11, 8, and 3 punches in the same card column.

There are fifteen exceptions to the punching equated to bit positions. These exceptions are shown in the chart by circled numbers 1 through 15, and the substituted punching is shown in Figure 65 under Exceptions.

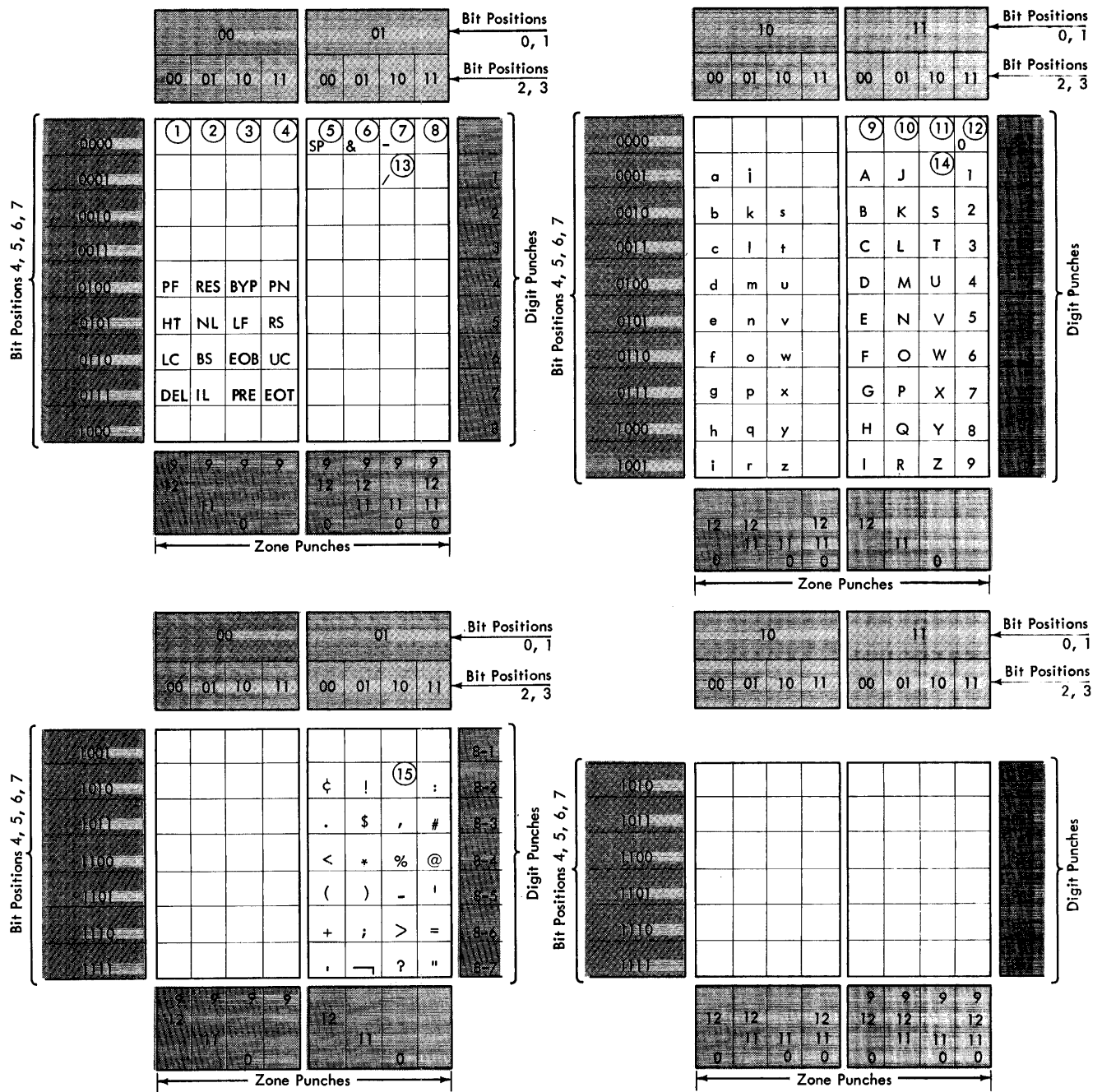

Exceptions:

- | | | | |
|-----------------|--------------|---------|------------|
| ① 12-0-9-8-1 | ⑤ No PUNCHES | ⑨ 12-0 | ⑬ 0-1 |
| ② 12-11-9-8-1 | ⑥ 12 | ⑩ 11-0 | ⑭ 11-0-9-1 |
| ③ 11-0-9-8-1 | ⑦ 11 | ⑪ 0-8-2 | ⑮ 12-11 |
| ④ 12-11-0-9-8-1 | ⑧ 12-11-0 | ⑫ 0 | |

Figure 63. Extended Binary Coded Decimal Interchange Code (Part 1 of 2)

Control Characters

PF	Punch Off	BS	Backspace	PN	Punch On
HT	Horizontal Tab	IL	Idle	RS	Reader Stop
LC	Lower Case	BYP	Bypass	UC	Upper Case
DEL	Delete	LF	Line Feed	EOT	End of Transmission
RES	Restore	EOB	End of Block	SP	Space
NL	New Line	PRE	Prefix		

Special Graphic Characters

¢	Cent Sign	*	Asterisk	>	Greater-than Sign
.	Period, Decimal Point)	Right Parenthesis	?	Question Mark
<	Less-than Sign	;	Semicolon	:	Colon
(Left Parenthesis	¬	Logical NOT	#	Number Sign
+	Plus Sign	-	Minus Sign, Hyphen	@	At Sign
	Vertical Bar, Logical OR	/	Slash	'	Prime, Apostrophe
&	Ampersand	,	Comma	=	Equal Sign
!	Exclamation Point	%	Percent	"	Quotation Mark
\$	Dollar Sign	_	Underscore		

Examples	Type	Bit Pattern Bit Positions 01 23 4567	Hole Pattern	
			Zone Punches	Digit Punches
PF	Control Character	00 00 0100	12 - 9 - 4	
%	Special Graphic	01 10 1100	0 - 8 - 4	
R	Upper Case	11 01 1001	11 - 9	
a	Lower Case	10 00 0001	12 - 0 - 1	
	Control Character, function not yet assigned	00 11 0000	12 - 11 - 0 - 9 - 8 - 1	

Figure 63. Extended Binary Coded Decimal Interchange Code (Part 2 of 2)

Two methods can be used to convert binary numbers to decimal. For example, given the binary number 1110 1100, the decimal equivalent 236 can be calculated.

Method 1

Assign a value to each bit position of the binary number and add the values of all bits that are one (not zero).

Assign the units position of the binary number the value of one. Assign the tens position the value of two, the hundreds position the value of four, etc. In this manner (doubling the value each time), assign values to all bit positions through the high-order bit.

To convert a particular binary number to decimal, add the values of all bit positions that are ones (not zeros).

Method 2

Multiply the high-order binary bit position by two, and add the next lower-order position of the binary number. Multiply again and add the next binary position. Continue this process until the last (units) position of the binary number is added. The accumulated total is the decimal number.

Thus $(1110\ 1100)_2 = (236)_{10}$, as follows:

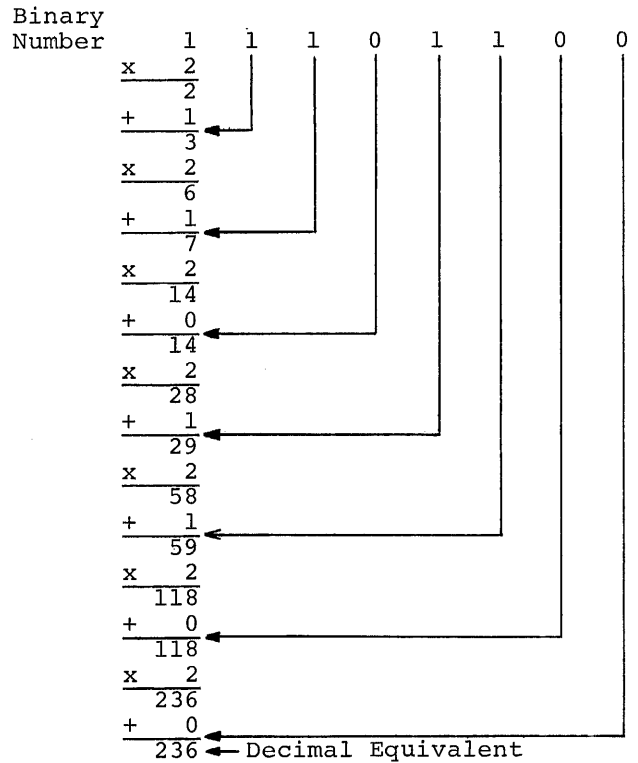

Thus $(1110\ 1100)_2 = (236)_{10}$, as follows:

Bit Position	0	1	2	3	4	5	6	7
Assigned Value	128	64	32	16	8	4	2	1
Binary Number	1	1	1	0	1	1	0	0
Therefore, $128 + 64 + 32 + 8 + 4 = 236$ (decimal equivalent of 1110 1100)								

APPENDIX C: BINARY TO HEXADECIMAL CONVERSION

System/360 operates with a four-bit binary code corresponding to the hexadecimal numbering system. Hexadecimal numbering is similar to decimal numbering except that the hex base is 16, where the decimal base is 10. In order to represent each of the 16 hex numbers as a single character, numbers greater than 9 are assigned alphabetic equivalents, as in the following list:

<u>Dec.</u>	<u>Hex.</u>
0	0
1	1
2	2
3	3
4	4
5	5
6	6
7	7
8	8
9	9
10	A
11	B
12	C
13	D
14	E
15	F

<u>Binary</u>	<u>Hex.</u>
0 0 0 0	0
0 0 0 1	1
0 0 1 0	2
0 0 1 1	3
0 1 0 0	4
0 1 0 1	5
0 1 1 0	6
0 1 1 1	7
1 0 0 0	8
1 0 0 1	9
1 0 1 0	A
1 0 1 1	B
1 1 0 0	C
1 1 0 1	D
1 1 1 0	E
1 1 1 1	F

A decal similar to this chart is fixed to the face of the System/360 System Control Panel (console).

The basis of System/360 numbering is the byte, an 8-bit binary number, or two hexadecimal characters. Each bit in a one-byte binary number is referred to by a bit-position number, 0 through 7. The 0 position is the left-most or high-order bit, and the 7 position is the right-most or low-order bit. Bit positions 0-3 represent the first hexadecimal character, and bit positions 4-7 represent the second hex character. The examples (Figure 64) show conversion of one-byte binary numbers to two character hexadecimal numbers.

Figure 65 gives the binary, decimal, and hexadecimal equivalents from 0 to 255. Where applicable, equivalent alphameric characters are also shown.

The System/360 System Control Panel (console) displays information through the four-bit binary code. A binary code is derived from a system whereby a bit that is present is said to be a one, and a bit that is not present is said to be a zero. The four-bit binary code is used to represent the hexadecimal numbers as in the following list:

One-Byte Binary Number					Hexadecimal Equivalent					
Bit Value	8	4	2	1	8	4	2	1	1st Character	2nd Character
Bit Position	0	1	2	3	4	5	6	7		
Examples	0	0	0	1	1	0	0	0	1	8
	0	0	1	0	0	0	0	0	2	0
	0	0	1	1	0	0	1	0	3	2
	0	1	0	0	1	1	0	0	4	C
	1	1	1	1	1	1	1	0	F	E

Figure 64. Examples of Binary to Hexadecimal Conversion

Binary		Printer Graphic	Decimal	Hexa-decimal
First Half Byte	Second Half Byte			
128 ↓ 64 ↓ 32 ↓ 16 ↓	8421			
0000	0000		0	00
0000	0001		1	01
0000	0010		2	02
0000	0011		3	03
0000	0100		4	04
0000	0101		5	05
0000	0110		6	06
0000	0111		7	07
0000	1000		8	08
0000	1001		9	09
0000	1010		10	0A
0000	1011		11	0B
0000	1100		12	0C
0000	1101		13	0D
0000	1110		14	0E
0000	1111		15	0F
0001	0000		16	10
0001	0001		17	11
0001	0010		18	12
0001	0011		19	13
0001	0100		20	14
0001	0101		21	15
0001	0110		22	16
0001	0111		23	17
0001	1000		24	18
0001	1001		25	19
0001	1010		26	1A
0001	1011		27	1B
0001	1100		28	1C
0001	1101		29	1D
0001	1110		30	1E
0001	1111		31	1F
0010	0000		32	20
0010	0001		33	21
0010	0010		34	22
0010	0011		35	23
0010	0100		36	24
0010	0101		37	25
0010	0110		38	26
0010	0111		39	27
0010	1000		40	28
0010	1001		41	29
0010	1010		42	2A
0010	1011		43	2B
0010	1100		44	2C
0010	1101		45	2D
0010	1110		46	2E
0010	1111		47	2F
0011	0000		48	30
0011	0001		49	31
0011	0010		50	32
0011	0011		51	33
0011	0100		52	34
0011	0101		53	35
0011	0110		54	36
0011	0111		55	37
0011	1000		56	38
0011	1001		57	39
0011	1010		58	3A
0011	1011		59	3B
0011	1100		60	3C
0011	1101		61	3D
0011	1110		62	3E
0011	1111		63	3F
0100	0000	blank	64	40

Binary		Printer Graphic	Decimal	Hexa-decimal
First Half Byte	Second Half Byte			
128 ↓ 64 ↓ 32 ↓ 16 ↓	8421			
0100	0001		65	41
0100	0010		66	42
0100	0011		67	43
0100	0100		68	44
0100	0101		69	45
0100	0110		70	46
0100	0111		71	47
0100	1000		72	48
0100	1001		73	49
0100	1010		74	4A
0100	1011	. (period)	75	4B
0100	1100	<-	76	4C
0100	1101	(77	4D
0100	1110	+	78	4E
0100	1111		79	4F
0101	0000	&	80	50
0101	0001		81	51
0101	0010		82	52
0101	0011		83	53
0101	0100		84	54
0101	0101		85	55
0101	0110		86	56
0101	0111		87	57
0101	1000		88	58
0101	1001		89	59
0101	1010		90	5A
0101	1011	\$	91	5B
0101	1100	*	92	5C
0101	1101)	93	5D
0101	1110		94	5E
0101	1111		95	5F
0110	0000	-	96	60
0110	0001	/	97	61
0110	0010		98	62
0110	0011		99	63
0110	0100		100	64
0110	0101		101	65
0110	0110		102	66
0110	0111		103	67
0110	1000		104	68
0110	1001		105	69
0110	1010		106	6A
0110	1011	,	107	6B
0110	1100	%	108	6C
0110	1101		109	6D
0110	1110		110	6E
0110	1111		111	6F
0111	0000		112	70
0111	0001		113	71
0111	0010		114	72
0111	0011		115	73
0111	0100		116	74
0111	0101		117	75
0111	0110		118	76
0111	0111		119	77
0111	1000		120	78
0111	1001		121	79
0111	1010		122	7A
0111	1011	#	123	7B
0111	1100	@	124	7C
0111	1101	.	125	7D
0111	1110	=	126	7E
0111	1111		127	7F
1000	0000		128	80
1000	0001		129	81

Figure 65. Binary, Decimal, and Hexadecimal Equivalents (Part 1 of 2)

Binary		Printer Graphic	Decimal	Hexa- decimal
First Half Byte	Second Half Byte			
128 64 32 16 ↓ ↓ ↓ ↓ 8421	8421			
1000	0010		130	82
1000	0011		131	83
1000	0100		132	84
1000	0101		133	85
1000	0110		134	86
1000	0111		135	87
1000	1000		136	88
1000	1001		137	89
1000	1010		138	8A
1000	1011		139	8B
1000	1100		140	8C
1000	1101		141	8D
1000	1110		142	8E
1000	1111		143	8F
1001	0000		144	90
1001	0001		145	91
1001	0010		146	92
1001	0011		147	93
1001	0100		148	94
1001	0101		149	95
1001	0110		150	96
1001	0111		151	97
1001	1000		152	98
1001	1001		153	99
1001	1010		154	9A
1001	1011		155	9B
1001	1100		156	9C
1001	1101		157	9D
1001	1110		158	9E
1001	1111		159	9F
1010	0000		160	A0
1010	0001		161	A1
1010	0010		162	A2
1010	0011		163	A3
1010	0100		164	A4
1010	0101		165	A5
1010	0110		166	A6
1010	0111		167	A7
1010	1000		168	A8
1010	1001		169	A9
1010	1010		170	AA
1010	1011		171	AB
1010	1100		172	AC
1010	1101		173	AD
1010	1110		174	AE
1010	1111		175	AF
1011	0000		176	B0
1011	0001		177	B1
1011	0010		178	B2
1011	0011		179	B3
1011	0100		180	B4
1011	0101		181	B5
1011	0110		182	B6
1011	0111		183	B7
1011	1000		184	B8
1011	1001		185	B9
1011	1010		186	BA
1011	1011		187	BB
1011	1100		188	BC
1011	1101		189	BD
1011	1110		190	BE
1011	1111		191	BF
1100	0000		192	C0

Binary		Printer Graphic	Decimal	Hexa- decimal
First Half Byte	Second Half Byte			
128 64 32 16 ↓ ↓ ↓ ↓ 8421	8421			
1100	0001	A	193	C1
1100	0010	B	194	C2
1100	0011	C	195	C3
1100	0100	D	196	C4
1100	0101	E	197	C5
1100	0110	F	198	C6
1100	0111	G	199	C7
1100	1000	H	200	C8
1100	1001	I	201	C9
1100	1010		202	CA
1100	1011		203	CB
1100	1100		204	CC
1100	1101		205	CD
1100	1110		206	CE
1100	1111		207	CF
1101	0000		208	D0
1101	0001	J	209	D1
1101	0010	K	210	D2
1101	0011	L	211	D3
1101	0100	M	212	D4
1101	0101	N	213	D5
1101	0110	O	214	D6
1101	0111	P	215	D7
1101	1000	Q	216	D8
1101	1001	R	217	D9
1101	1010		218	DA
1101	1011		219	DB
1101	1100		220	DC
1101	1101		221	DD
1101	1110		222	DE
1101	1111		223	DF
1110	0000		224	E0
1110	0001		225	E1
1110	0010	S	226	E2
1110	0011	T	227	E3
1110	0100	U	228	E4
1110	0101	V	229	E5
1110	0110	W	230	E6
1110	0111	X	231	E7
1110	1000	Y	232	E8
1110	1001	Z	233	E9
1110	1010		234	EA
1110	1011		235	EB
1110	1100		236	EC
1110	1101		237	ED
1110	1110		238	EE
1110	1111		239	EF
1111	0000	0	240	F0
1111	0001	1	241	F1
1111	0010	2	242	F2
1111	0011	3	243	F3
1111	0100	4	244	F4
1111	0101	5	245	F5
1111	0110	6	246	F6
1111	0111	7	247	F7
1111	1000	8	248	F8
1111	1001	9	249	F9
1111	1010		250	FA
1111	1011		251	FB
1111	1100		252	FC
1111	1101		253	FD
1111	1110		254	FE
1111	1111		255	FF

Figure 65. Binary, Decimal, and Hexadecimal Equivalents (Part 2 of 2)

DECIMAL TO HEXADECIMAL

Decimal numbers are converted to hexadecimal as follows:

Divide the decimal number by 16. The remainder is the units position hexadecimal character, where 0 = 0, 15 = F, etc. Continue to divide the quotient by 16 until it is less than 16. Each succeeding remainder becomes the next higher order hex character. For example, $333 \div 16 = 20 + 13$ remaining. The 13 (D in hex) becomes the units character. $20 \div 16 = 1 + 4$ remaining. The four becomes the tens position hex character. $1 \div 16 = 0 + 1$ remaining. The one becomes the hundreds position hex character.

Thus $(333)_{10} = (14D)_{16}$, as follows:

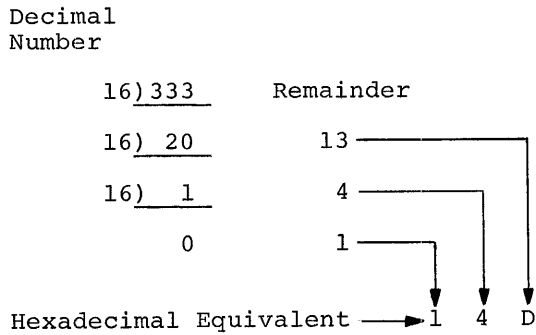

A hexadecimal/decimal conversion table is shown in Figure 66.

HEXADECIMAL TO DECIMAL

Multiply the high-order hex character by 16 and add the next lower-order hex character to this product. Multiply this sum by 16 and add the next lower hex character. Continue this process until the units position of the hex number has been added. The accumulated total is the decimal number. In the event of an alphabetic hex character (a number larger than 9), add the decimal equivalent as shown in the following list.

<u>Hex.</u>	<u>Dec.</u>
0	0
1	1
2	2
3	3
4	4
5	5
6	6
7	7
8	8
9	9
A	10
B	11
C	12
D	13
E	14
F	15

Thus, $(271C)_{16} = (10,012)_{10}$ as follows:

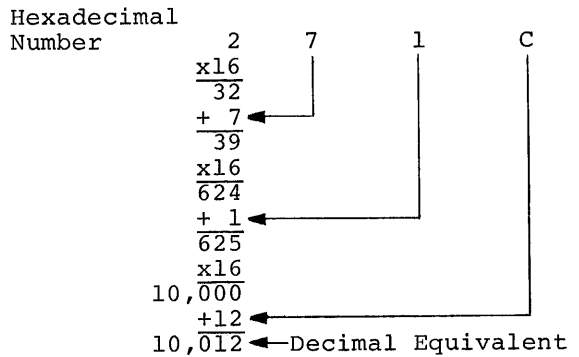

HEXADECIMAL/DECIMAL CONVERSION TABLE

This table provides for direct conversion of decimal and hexadecimal numbers in these ranges:

<u>Hexadecimal</u>	<u>Decimal</u>
000 to FFF	0000 to 4095

Decimal numbers (0000-4095) are given within the 5-part table. The first two characters (high-order) of hexadecimal numbers (000-FFF) are given in the lefthand column of the table; the third character (x) is arranged across the top of each part of the table.

To find the decimal equivalent of the hexadecimal number 0C9, look for 0C in the left column, and across that row under the column for x = 9. The decimal number is 0201.

To convert from decimal to hexadecimal, look up the decimal number within the table and read the hexadecimal number by a combination of the hex characters in the left column, and the value for x at the top of the column containing the decimal number. For example, the decimal number 123 has the hexadecimal equivalent of 07B; the decimal number 1478 has the hexadecimal equivalent of 5C6.

For numbers outside the range of the table, add the following values to the table figures:

<u>Hexadecimal</u>	<u>Decimal</u>
1000	4096
2000	8192
3000	12288
4000	16384
5000	20480
6000	24576
7000	28672
8000	32768
9000	36864
A000	40960
B000	45056
C000	49152
D000	53248
E000	57344
F000	61440

x =	0	1	2	3	4	5	6	7	8	9	A	B	C	D	E	F
00x	0000	0001	0002	0003	0004	0005	0006	0007	0008	0009	0010	0011	0012	0013	0014	0015
01x	0016	0017	0018	0019	0020	0021	0022	0023	0024	0025	0026	0027	0028	0029	0030	0031
02x	0032	0033	0034	0035	0036	0037	0038	0039	0040	0041	0042	0043	0044	0045	0046	0047
03x	0048	0049	0050	0051	0052	0053	0054	0055	0056	0057	0058	0059	0060	0061	0062	0063
04x	0064	0065	0066	0067	0068	0069	0070	0071	0072	0073	0074	0075	0076	0077	0078	0079
05x	0080	0081	0082	0083	0084	0085	0086	0087	0088	0089	0090	0091	0092	0093	0094	0095
06x	0096	0097	0098	0099	0100	0101	0102	0103	0104	0105	0106	0107	0108	0109	0110	0111
07x	0112	0113	0114	0115	0116	0117	0118	0119	0120	0121	0122	0123	0124	0125	0126	0127
08x	0128	0129	0130	0131	0132	0133	0134	0135	0136	0137	0138	0139	0140	0141	0142	0143
09x	0144	0145	0146	0147	0148	0149	0150	0151	0152	0153	0154	0155	0156	0157	0158	0159
0Ax	0160	0161	0162	0163	0164	0165	0166	0167	0168	0169	0170	0171	0172	0173	0174	0175
0Bx	0176	0177	0178	0179	0180	0181	0182	0183	0184	0185	0186	0187	0188	0189	0190	0191
0Cx	0192	0193	0194	0195	0196	0197	0198	0199	0200	0201	0202	0203	0204	0205	0206	0207
0Dx	0208	0209	0210	0211	0212	0213	0214	0215	0216	0217	0218	0219	0220	0221	0222	0223
0Ex	0224	0225	0226	0227	0228	0229	0230	0231	0232	0233	0234	0235	0236	0237	0238	0239
0Fx	0240	0241	0242	0243	0244	0245	0246	0247	0248	0249	0250	0251	0252	0253	0254	0255
10x	0256	0257	0258	0259	0260	0261	0262	0263	0264	0265	0266	0267	0268	0269	0270	0271
11x	0272	0273	0274	0275	0276	0277	0278	0279	0280	0281	0282	0283	0284	0285	0286	0287
12x	0288	0289	0290	0291	0292	0293	0294	0295	0296	0297	0298	0299	0300	0301	0302	0303
13x	0304	0305	0306	0307	0308	0309	0310	0311	0312	0313	0314	0315	0316	0317	0318	0319
14x	0320	0321	0322	0323	0324	0325	0326	0327	0328	0329	0330	0331	0332	0333	0334	0335
15x	0336	0337	0338	0339	0340	0341	0342	0343	0344	0345	0346	0347	0348	0349	0350	0351
16x	0352	0353	0354	0355	0356	0357	0358	0359	0360	0361	0362	0363	0364	0365	0366	0367
17x	0368	0369	0370	0371	0372	0373	0374	0375	0376	0377	0378	0379	0380	0381	0382	0383
18x	0384	0385	0386	0387	0388	0389	0390	0391	0392	0393	0394	0395	0396	0397	0398	0399
19x	0400	0401	0402	0403	0404	0405	0406	0407	0408	0409	0410	0411	0412	0413	0414	0415
1Ax	0416	0417	0418	0419	0420	0421	0422	0423	0424	0425	0426	0427	0428	0429	0430	0431
1Bx	0432	0433	0434	0435	0436	0437	0438	0439	0440	0441	0442	0443	0444	0445	0446	0447
1Cx	0448	0449	0450	0451	0452	0453	0454	0455	0456	0457	0458	0459	0460	0461	0462	0463
1Dx	0464	0465	0466	0467	0468	0469	0470	0471	0472	0473	0474	0475	0476	0477	0478	0479
1Ex	0480	0481	0482	0483	0484	0485	0486	0487	0488	0489	0490	0491	0492	0493	0494	0495
1Fx	0496	0497	0498	0499	0500	0501	0502	0503	0504	0505	0506	0507	0508	0509	0510	0511
20x	0512	0513	0514	0515	0516	0517	0518	0519	0520	0521	0522	0523	0524	0525	0526	0527
21x	0528	0529	0530	0531	0532	0533	0534	0535	0536	0537	0538	0539	0540	0541	0542	0543
22x	0544	0545	0546	0547	0548	0549	0550	0551	0552	0553	0554	0555	0556	0557	0558	0559
23x	0560	0561	0562	0563	0564	0565	0566	0567	0568	0569	0570	0571	0572	0573	0574	0575
24x	0576	0577	0578	0579	0580	0581	0582	0583	0584	0585	0586	0587	0588	0589	0590	0591
25x	0592	0593	0594	0595	0596	0597	0598	0599	0600	0601	0602	0603	0604	0605	0606	0607
26x	0608	0609	0610	0611	0612	0613	0614	0615	0616	0617	0618	0619	0620	0621	0622	0623
27x	0624	0625	0626	0627	0628	0629	0630	0631	0632	0633	0634	0635	0636	0637	0638	0639
28x	0640	0641	0642	0643	0644	0645	0646	0647	0648	0649	0650	0651	0652	0653	0654	0655
29x	0656	0657	0658	0659	0660	0661	0662	0663	0664	0665	0666	0667	0668	0669	0670	0671
2Ax	0672	0673	0674	0675	0676	0677	0678	0679	0680	0681	0682	0683	0684	0685	0686	0687
2Bx	0688	0689	0690	0691	0692	0693	0694	0695	0696	0697	0698	0699	0700	0701	0702	0703
2Cx	0704	0705	0706	0707	0708	0709	0710	0711	0712	0713	0714	0715	0716	0717	0718	0719
2Dx	0720	0721	0722	0723	0724	0725	0726	0727	0728	0729	0730	0731	0732	0733	0734	0735
2Ex	0736	0737	0738	0739	0740	0741	0742	0743	0744	0745	0746	0747	0748	0749	0750	0751
2Fx	0752	0753	0754	0755	0756	0757	0758	0759	0760	0761	0762	0763	0764	0765	0766	0767
30x	0768	0769	0770	0771	0772	0773	0774	0775	0776	0777	0778	0779	0780	0781	0782	0783
31x	0784	0785	0786	0787	0788	0789	0790	0791	0792	0793	0794	0795	0796	0797	0798	0799
32x	0800	0801	0802	0803	0804	0805	0806	0807	0808	0809	0810	0811	0812	0813	0814	0815
33x	0816	0817	0818	0819	0820	0821	0822	0823	0824	0825	0826	0827	0828	0829	0830	0831
34x	0832	0833	0834	0835	0836	0837	0838	0839	0840	0841	0842	0843	0844	0845	0846	0847
35x	0848	0849	0850	0851	0852	0853	0854	0855	0856	0857	0858	0859	0860	0861	0862	0863
36x	0864	0865	0866	0867	0868	0869	0870	0871	0872	0873	0874	0875	0876	0877	0878	0879
37x	0880	0881	0882	0883	0884	0885	0886	0887	0888	0889	0890	0891	0892	0893	0894	0895
38x	0896	0897	0898	0899	0900	0901	0902	0903	0904	0905	0906	0907	0908	0909	0910	0911
39x	0912	0913	0914	0915	0916	0917	0918	0919	0920	0921	0922	0923	0924	0925	0926	0927
3Ax	0928	0929	0930	0931	0932	0933	0934	0935	0936	0937	0938	0939	0940	0941	0942	0943
3Bx	0944	0945	0946	0947	0948	0949	0950	0951	0952	0953	0954	0955	0956	0957	0958	0959
3Cx	0960	0961	0962	0963	0964	0965	0966	0967	0968	0969	0970	0971	0972	0973	0974	0975
3Dx	0976	0977	0978	0979	0980	0981	0982	0983	0984	0985	0986	0987	0988	0989	0990	0991
3Ex	0992	0993	0994	0995	0996	0997	0998	0999	1000	1001	1002	1003	1004	1005	1006	1007
3Fx	1008	1009	1010	1011	1012	1013	1014	1015	1016	1017	1018	1019	1020	1021	1022	1023

Figure 66. Hexadecimal/Decimal Conversion Table (Part 1 of 4)

x =	0	1	2	3	4	5	6	7	8	9	A	B	C	D	E	F
40x	1024	1025	1026	1027	1028	1029	1030	1031	1032	1033	1034	1035	1036	1037	1038	1039
41x	1040	1041	1042	1043	1044	1045	1046	1047	1048	1049	1050	1051	1052	1053	1054	1055
42x	1056	1057	1058	1059	1060	1061	1062	1063	1064	1065	1066	1067	1068	1069	1070	1071
43x	1072	1073	1074	1075	1076	1077	1078	1079	1080	1081	1082	1083	1084	1085	1086	1087
44x	1088	1089	1090	1091	1092	1093	1094	1095	1096	1097	1098	1099	1100	1101	1102	1103
45x	1104	1105	1106	1107	1108	1109	1110	1111	1112	1113	1114	1115	1116	1117	1118	1119
46x	1120	1121	1122	1123	1124	1125	1126	1127	1128	1129	1130	1131	1132	1133	1134	1135
47x	1136	1137	1138	1139	1140	1141	1142	1143	1144	1145	1146	1147	1148	1149	1150	1151
48x	1152	1153	1154	1155	1156	1157	1158	1159	1160	1161	1162	1163	1164	1165	1166	1167
49x	1168	1169	1170	1171	1172	1173	1174	1175	1176	1177	1178	1179	1180	1181	1182	1183
4Ax	1184	1185	1186	1187	1188	1189	1190	1191	1192	1193	1194	1195	1196	1197	1198	1199
4Bx	1200	1201	1202	1203	1204	1205	1206	1207	1208	1209	1210	1211	1212	1213	1214	1215
4Cx	1216	1217	1218	1219	1220	1221	1222	1223	1224	1225	1226	1227	1228	1229	1230	1231
4Dx	1232	1233	1234	1235	1236	1237	1238	1239	1240	1241	1242	1243	1244	1245	1246	1247
4Ex	1248	1249	1250	1251	1252	1253	1254	1255	1256	1257	1258	1259	1260	1261	1262	1263
4Fx	1264	1265	1266	1267	1268	1269	1270	1271	1272	1273	1274	1275	1276	1277	1278	1279
50x	1280	1281	1282	1283	1284	1285	1286	1287	1288	1289	1290	1291	1292	1293	1294	1295
51x	1296	1297	1298	1299	1300	1301	1302	1303	1304	1305	1306	1307	1308	1309	1310	1311
52x	1312	1313	1314	1315	1316	1317	1318	1319	1320	1321	1322	1323	1324	1325	1326	1327
53x	1328	1329	1330	1331	1332	1333	1334	1335	1336	1337	1338	1339	1340	1341	1342	1343
54x	1344	1345	1346	1347	1348	1349	1350	1351	1352	1353	1354	1355	1356	1357	1358	1359
55x	1360	1361	1362	1363	1364	1365	1366	1367	1368	1369	1370	1371	1372	1373	1374	1375
56x	1376	1377	1378	1379	1380	1381	1382	1383	1384	1385	1386	1387	1388	1389	1390	1391
57x	1392	1393	1394	1395	1396	1397	1398	1399	1400	1401	1402	1403	1404	1405	1406	1407
58x	1408	1409	1410	1411	1412	1413	1414	1415	1416	1417	1418	1419	1420	1421	1422	1423
59x	1424	1425	1426	1427	1428	1429	1430	1431	1432	1433	1434	1435	1436	1437	1438	1439
5Ax	1440	1441	1442	1443	1444	1445	1446	1447	1448	1449	1450	1451	1452	1453	1454	1455
5Bx	1456	1457	1458	1459	1460	1461	1462	1463	1464	1465	1466	1467	1468	1469	1470	1471
5Cx	1472	1473	1474	1475	1476	1477	1478	1479	1480	1481	1482	1483	1484	1485	1486	1487
5Dx	1488	1489	1490	1491	1492	1493	1494	1495	1496	1497	1498	1499	1500	1501	1502	1503
5Ex	1504	1505	1506	1507	1508	1509	1510	1511	1512	1513	1514	1515	1516	1517	1518	1519
5Fx	1520	1521	1522	1523	1524	1525	1526	1527	1528	1529	1530	1531	1532	1533	1534	1535
60x	1536	1537	1538	1539	1540	1541	1542	1543	1544	1545	1546	1547	1548	1549	1550	1551
61x	1552	1553	1554	1555	1556	1557	1558	1559	1560	1561	1562	1563	1564	1565	1566	1567
62x	1568	1569	1570	1571	1572	1573	1574	1575	1576	1577	1578	1579	1580	1581	1582	1583
63x	1584	1585	1586	1587	1588	1589	1590	1591	1592	1593	1594	1595	1596	1597	1598	1599
64x	1600	1601	1602	1603	1604	1605	1606	1607	1608	1609	1610	1611	1612	1613	1614	1615
65x	1616	1617	1618	1619	1620	1621	1622	1623	1624	1625	1626	1627	1628	1629	1630	1631
66x	1632	1633	1634	1635	1636	1637	1638	1639	1640	1641	1642	1643	1644	1645	1646	1647
67x	1648	1649	1650	1651	1652	1653	1654	1655	1656	1657	1658	1659	1660	1661	1662	1663
68x	1664	1665	1666	1667	1668	1669	1670	1671	1672	1673	1674	1675	1676	1677	1678	1679
69x	1680	1681	1682	1683	1684	1685	1686	1687	1688	1689	1690	1691	1692	1693	1694	1695
6Ax	1696	1697	1698	1699	1700	1701	1702	1703	1704	1705	1706	1707	1708	1709	1710	1711
6Bx	1712	1713	1714	1715	1716	1717	1718	1719	1720	1721	1722	1723	1724	1725	1726	1727
6Cx	1728	1729	1730	1731	1732	1733	1734	1735	1736	1737	1738	1739	1740	1741	1742	1743
6Dx	1744	1745	1746	1747	1748	1749	1750	1751	1752	1753	1754	1755	1756	1757	1758	1759
6Ex	1760	1761	1762	1763	1764	1765	1766	1767	1768	1769	1770	1771	1772	1773	1774	1775
6Fx	1776	1777	1778	1779	1780	1781	1782	1783	1784	1785	1786	1787	1788	1789	1790	1791
70x	1792	1793	1794	1795	1796	1797	1798	1799	1800	1801	1802	1803	1804	1805	1806	1807
71x	1808	1809	1810	1811	1812	1813	1814	1815	1816	1817	1818	1819	1820	1821	1822	1823
72x	1824	1825	1826	1827	1828	1829	1830	1831	1832	1833	1834	1835	1836	1837	1838	1839
73x	1840	1841	1842	1843	1844	1845	1846	1847	1848	1849	1850	1851	1852	1853	1854	1855
74x	1856	1857	1858	1859	1860	1861	1862	1863	1864	1865	1866	1867	1868	1869	1870	1871
75x	1872	1873	1874	1875	1876	1877	1878	1879	1880	1881	1882	1883	1884	1885	1886	1887
76x	1888	1889	1890	1891	1892	1893	1894	1895	1896	1897	1898	1899	1900	1901	1902	1903
77x	1904	1905	1906	1907	1908	1909	1910	1911	1912	1913	1914	1915	1916	1917	1918	1919
78x	1920	1921	1922	1923	1924	1925	1926	1927	1928	1929	1930	1931	1932	1933	1934	1935
79x	1936	1937	1938	1939	1940	1941	1942	1943	1944	1945	1946	1947	1948	1949	1950	1951
7Ax	1952	1953	1954	1955	1956	1957	1958	1959	1960	1961	1962	1963	1964	1965	1966	1967
7Bx	1968	1969	1970	1971	1972	1973	1974	1975	1976	1977	1978	1979	1980	1981	1982	1983
7Cx	1984	1985	1986	1987	1988	1989	1990	1991	1992	1993	1994	1995	1996	1997	1998	1999
7Dx	2000	2001	2002	2003	2004	2005	2006	2007	2008	2009	2010	2011	2012	2013	2014	2015
7Ex	2016	2017	2018	2019	2020	2021	2022	2023	2024	2025	2026	2027	2028	2029	2030	2031
7Fx	2032	2033	2034	2035	2036	2037	2038	2039	2040	2041	2042	2043	2044	2045	2046	2047

Figure 66. Hexadecimal/Decimal Conversion Table (Part 2 of 4)

x =	0	1	2	3	4	5	6	7	8	9	A	B	C	D	E	F
80x	2048	2049	2050	2051	2052	2053	2054	2055	2056	2057	2058	2059	2060	2061	2062	2063
81x	2064	2065	2066	2067	2068	2069	2070	2071	2072	2073	2074	2075	2076	2077	2078	2079
82x	2080	2081	2082	2083	2084	2085	2086	2087	2088	2089	2090	2091	2092	2093	2094	2095
83x	2096	2097	2098	2099	2100	2101	2102	2103	2104	2105	2106	2107	2108	2109	2110	2111
84x	2112	2113	2114	2115	2116	2117	2118	2119	2120	2121	2122	2123	2124	2125	2126	2127
85x	2128	2129	2130	2131	2132	2133	2134	2135	2136	2137	2138	2139	2140	2141	2142	2143
86x	2144	2145	2146	2147	2148	2149	2150	2151	2152	2153	2154	2155	2156	2157	2158	2159
87x	2160	2161	2162	2163	2164	2165	2166	2167	2168	2169	2170	2171	2172	2173	2174	2175
88x	2176	2177	2178	2179	2180	2181	2182	2183	2184	2185	2186	2187	2188	2189	2190	2191
89x	2192	2193	2194	2195	2196	2197	2198	2199	2200	2201	2202	2203	2204	2205	2206	2207
8Ax	2208	2209	2210	2211	2212	2213	2214	2215	2216	2217	2218	2219	2220	2221	2222	2223
8Bx	2224	2225	2226	2227	2228	2229	2230	2231	2232	2233	2234	2235	2236	2237	2238	2239
8Cx	2240	2241	2242	2243	2244	2245	2246	2247	2248	2249	2250	2251	2252	2253	2254	2255
8Dx	2256	2257	2258	2259	2260	2261	2262	2263	2264	2265	2266	2267	2268	2269	2270	2271
8Ex	2272	2273	2274	2275	2276	2277	2278	2279	2280	2281	2282	2283	2284	2285	2286	2287
8Fx	2288	2289	2290	2291	2292	2293	2294	2295	2296	2297	2298	2299	2300	2301	2302	2303
90x	2304	2305	2306	2307	2308	2309	2310	2311	2312	2313	2314	2315	2316	2317	2318	2319
91x	2320	2321	2322	2323	2324	2325	2326	2327	2328	2329	2330	2331	2332	2333	2334	2335
92x	2336	2337	2338	2339	2340	2341	2342	2343	2344	2345	2346	2347	2348	2349	2350	2351
93x	2352	2353	2354	2355	2356	2357	2358	2359	2360	2361	2362	2363	2364	2365	2366	2367
94x	2368	2369	2370	2371	2372	2373	2374	2375	2376	2377	2378	2379	2380	2381	2382	2383
95x	2384	2385	2386	2387	2388	2389	2390	2391	2392	2393	2394	2395	2396	2397	2398	2399
96x	2400	2401	2402	2403	2404	2405	2406	2407	2408	2409	2410	2411	2412	2413	2414	2415
97x	2416	2417	2418	2419	2420	2421	2422	2423	2424	2425	2426	2427	2428	2429	2430	2431
98x	2432	2433	2434	2435	2436	2437	2438	2439	2440	2441	2442	2443	2444	2445	2446	2447
99x	2448	2449	2450	2451	2452	2453	2454	2455	2456	2457	2458	2459	2460	2461	2462	2463
9Ax	2464	2465	2466	2467	2468	2469	2470	2471	2472	2473	2474	2475	2476	2477	2478	2479
9Bx	2480	2481	2482	2483	2484	2485	2486	2487	2488	2489	2490	2491	2492	2493	2494	2495
9Cx	2496	2497	2498	2499	2500	2501	2502	2503	2504	2505	2506	2507	2508	2509	2510	2511
9Dx	2512	2513	2514	2515	2516	2517	2518	2519	2520	2521	2522	2523	2524	2525	2526	2527
9Ex	2528	2529	2530	2531	2532	2533	2534	2535	2536	2537	2538	2539	2540	2541	2542	2543
9Fx	2544	2545	2546	2547	2548	2549	2550	2551	2552	2553	2554	2555	2556	2557	2558	2559
A0x	2560	2561	2562	2563	2564	2565	2566	2567	2568	2569	2570	2571	2572	2573	2574	2575
A1x	2576	2577	2578	2579	2580	2581	2582	2583	2584	2585	2586	2587	2588	2589	2590	2591
A2x	2592	2593	2594	2595	2596	2597	2598	2599	2600	2601	2602	2603	2604	2605	2606	2607
A3x	2608	2609	2610	2611	2612	2613	2614	2615	2616	2617	2618	2619	2620	2621	2622	2623
A4x	2624	2625	2626	2627	2628	2629	2630	2631	2632	2633	2634	2635	2636	2637	2638	2639
A5x	2640	2641	2642	2643	2644	2645	2646	2647	2648	2649	2650	2651	2652	2653	2654	2655
A6x	2656	2657	2658	2659	2660	2661	2662	2663	2664	2665	2666	2667	2668	2669	2670	2671
A7x	2672	2673	2674	2675	2676	2677	2678	2679	2680	2681	2682	2683	2684	2685	2686	2687
A8x	2688	2689	2690	2691	2692	2693	2694	2695	2696	2697	2698	2699	2700	2701	2702	2703
A9x	2704	2705	2706	2707	2708	2709	2710	2711	2712	2713	2714	2715	2716	2717	2718	2719
AAx	2720	2721	2722	2723	2724	2725	2726	2727	2728	2729	2730	2731	2732	2733	2734	2735
ABx	2736	2737	2738	2739	2740	2741	2742	2743	2744	2745	2746	2747	2748	2749	2750	2751
ACx	2752	2753	2754	2755	2756	2757	2758	2759	2760	2761	2762	2763	2764	2765	2766	2767
ADx	2768	2769	2770	2771	2772	2773	2774	2775	2776	2777	2778	2779	2780	2781	2782	2783
AEx	2784	2785	2786	2787	2788	2789	2790	2791	2792	2793	2794	2795	2796	2797	2798	2799
AFx	2800	2801	2802	2803	2804	2805	2806	2807	2808	2809	2810	2811	2812	2813	2814	2815
B0x	2816	2817	2818	2819	2820	2821	2822	2823	2824	2825	2826	2827	2828	2829	2830	2831
B1x	2832	2833	2834	2835	2836	2837	2838	2839	2840	2841	2842	2843	2844	2845	2846	2847
B2x	2848	2849	2850	2851	2852	2853	2854	2855	2856	2857	2858	2859	2860	2861	2862	2863
B3x	2864	2865	2866	2867	2868	2869	2870	2871	2872	2873	2874	2875	2876	2877	2878	2879
B4x	2880	2881	2882	2883	2884	2885	2886	2887	2888	2889	2890	2891	2892	2893	2894	2895
B5x	2896	2897	2898	2899	2900	2901	2902	2903	2904	2905	2906	2907	2908	2909	2910	2911
B6x	2912	2913	2914	2915	2916	2917	2918	2919	2920	2921	2922	2923	2924	2925	2926	2927
B7x	2928	2929	2930	2931	2932	2933	2934	2935	2936	2937	2938	2939	2940	2941	2942	2943
B8x	2944	2945	2946	2947	2948	2949	2950	2951	2952	2953	2954	2955	2956	2957	2958	2959
B9x	2960	2961	2962	2963	2964	2965	2966	2967	2968	2969	2970	2971	2972	2973	2974	2975
BAx	2976	2977	2978	2979	2980	2981	2982	2983	2984	2985	2986	2987	2988	2989	2990	2991
BBx	2992	2993	2994	2995	2996	2997	2998	2999	3000	3001	3002	3003	3004	3005	3006	3007
BCx	3008	3009	3010	3011	3012	3013	3014	3015	3016	3017	3018	3019	3020	3021	3022	3023
BDx	3024	3025	3026	3027	3028	3029	3030	3031	3032	3033	3034	3035	3036	3037	3038	3039
BEx	3040	3041	3042	3043	3044	3045	3046	3047	3048	3049	3050	3051	3052	3053	3054	3055
BFx	3056	3057	3058	3059	3060	3061	3062	3063	3064	3065	3066	3067	3068	3069	3070	3071

Figure 66. Hexadecimal/Decimal Conversion Table (Part 3 of 4)

x =	0	1	2	3	4	5	6	7	8	9	A	B	C	D	E	F
C0x	3072	3073	3074	3075	3076	3077	3078	3079	3080	3081	3082	3083	3084	3085	3086	3087
C1x	3088	3089	3090	3091	3092	3093	3094	3095	3096	3097	3098	3099	3100	3101	3102	3103
C2x	3104	3105	3106	3107	3108	3109	3110	3111	3112	3113	3114	3115	3116	3117	3118	3119
C3x	3120	3121	3122	3123	3124	3125	3126	3127	3128	3129	3130	3131	3132	3133	3134	3135
C4x	3136	3137	3138	3139	3140	3141	3142	3143	3144	3145	3146	3147	3148	3149	3150	3151
C5x	3152	3153	3154	3155	3156	3157	3158	3159	3160	3161	3162	3163	3164	3165	3166	3167
C6x	3168	3169	3170	3171	3172	3173	3174	3175	3176	3177	3178	3179	3180	3181	3182	3183
C7x	3184	3185	3186	3187	3188	3189	3190	3191	3192	3193	3194	3195	3196	3197	3198	3199
C8x	3200	3201	3202	3203	3204	3205	3206	3207	3208	3209	3210	3211	3212	3213	3214	3215
C9x	3216	3217	3218	3219	3220	3221	3222	3223	3224	3225	3226	3227	3228	3229	3230	3231
CAx	3232	3233	3234	3235	3236	3237	3238	3239	3240	3241	3242	3243	3244	3245	3246	3247
CBx	3248	3249	3250	3251	3252	3253	3254	3255	3256	3257	3258	3259	3260	3261	3262	3263
CCx	3264	3265	3266	3267	3268	3269	3270	3271	3272	3273	3274	3275	3276	3277	3278	3279
CDx	3280	3281	3282	3283	3284	3285	3286	3287	3288	3289	3290	3291	3292	3293	3294	3295
CEx	3296	3297	3298	3299	3300	3301	3302	3303	3304	3305	3306	3307	3308	3309	3310	3311
CFx	3312	3313	3314	3315	3316	3317	3318	3319	3320	3321	3322	3323	3324	3325	3326	3327
D0x	3328	3329	3330	3331	3332	3333	3334	3335	3336	3337	3338	3339	3340	3341	3342	3343
D1x	3344	3345	3346	3347	3348	3349	3350	3351	3352	3353	3354	3355	3356	3357	3358	3359
D2x	3360	3361	3362	3363	3364	3365	3366	3367	3368	3369	3370	3371	3372	3373	3374	3375
D3x	3376	3377	3378	3379	3380	3381	3382	3383	3384	3385	3386	3387	3388	3389	3390	3391
D4x	3392	3393	3394	3395	3396	3397	3398	3399	3400	3401	3402	3403	3404	3405	3406	3407
D5x	3408	3409	3410	3411	3412	3413	3414	3415	3416	3417	3418	3419	3420	3421	3422	3423
D6x	3424	3425	3426	3427	3428	3429	3430	3431	3432	3433	3434	3435	3436	3437	3438	3439
D7x	3440	3441	3442	3443	3444	3445	3446	3447	3448	3449	3450	3451	3452	3453	3454	3455
D8x	3456	3457	3458	3459	3460	3461	3462	3463	3464	3465	3466	3467	3468	3469	3470	3471
D9x	3472	3473	3474	3475	3476	3477	3478	3479	3480	3481	3482	3483	3484	3485	3486	3487
DAx	3488	3489	3490	3491	3492	3493	3494	3495	3496	3497	3498	3499	3500	3501	3502	3503
DBx	3504	3505	3506	3507	3508	3509	3510	3511	3512	3513	3514	3515	3516	3517	3518	3519
DCx	3520	3521	3522	3523	3524	3525	3526	3527	3528	3529	3530	3531	3532	3533	3534	3535
DDx	3536	3537	3538	3539	3540	3541	3542	3543	3544	3545	3546	3547	3548	3549	3550	3551
DEx	3552	3553	3554	3555	3556	3557	3558	3559	3560	3561	3562	3563	3564	3565	3566	3567
DFx	3568	3569	3570	3571	3572	3573	3574	3575	3576	3577	3578	3579	3580	3581	3582	3583
E0x	3584	3585	3586	3587	3588	3589	3590	3591	3592	3593	3594	3595	3596	3597	3598	3599
E1x	3600	3601	3602	3603	3604	3605	3606	3607	3608	3609	3610	3611	3612	3613	3614	3615
E2x	3616	3617	3618	3619	3620	3621	3622	3623	3624	3625	3626	3627	3628	3629	3630	3631
E3x	3632	3633	3634	3635	3636	3637	3638	3639	3640	3641	3642	3643	3644	3645	3646	3647
E4x	3648	3649	3650	3651	3652	3653	3654	3655	3656	3657	3658	3659	3660	3661	3662	3663
E5x	3664	3665	3666	3667	3668	3669	3670	3671	3672	3673	3674	3675	3676	3677	3678	3679
E6x	3680	3681	3682	3683	3684	3685	3686	3687	3688	3689	3690	3691	3692	3693	3694	3695
E7x	3696	3697	3698	3699	3700	3701	3702	3703	3704	3705	3706	3707	3708	3709	3710	3711
E8x	3712	3713	3714	3715	3716	3717	3718	3719	3720	3721	3722	3723	3724	3725	3726	3727
E9x	3728	3729	3730	3731	3732	3733	3734	3735	3736	3737	3738	3739	3740	3741	3742	3743
EAx	3744	3745	3746	3747	3748	3749	3750	3751	3752	3753	3754	3755	3756	3757	3758	3759
EBx	3760	3761	3762	3763	3764	3765	3766	3767	3768	3769	3770	3771	3772	3773	3774	3775
ECx	3776	3777	3778	3779	3780	3781	3782	3783	3784	3785	3786	3787	3788	3789	3790	3791
EDx	3792	3793	3794	3795	3796	3797	3798	3799	3800	3801	3802	3803	3804	3805	3806	3807
EEx	3808	3809	3810	3811	3812	3813	3814	3815	3816	3817	3818	3819	3820	3821	3822	3823
EFx	3824	3825	3826	3827	3828	3829	3830	3831	3832	3833	3834	3835	3836	3837	3838	3839
F0x	3840	3841	3842	3843	3844	3845	3846	3847	3848	3849	3850	3851	3852	3853	3854	3855
F1x	3856	3857	3858	3859	3860	3861	3862	3863	3864	3865	3866	3867	3868	3869	3870	3871
F2x	3872	3873	3874	3875	3876	3877	3878	3879	3880	3881	3882	3883	3884	3885	3886	3887
F3x	3888	3889	3890	3891	3892	3893	3894	3895	3896	3897	3898	3899	3900	3901	3902	3903
F4x	3904	3905	3906	3907	3908	3909	3910	3911	3912	3913	3914	3915	3916	3917	3918	3919
F5x	3920	3921	3922	3923	3924	3925	3926	3927	3928	3929	3930	3931	3932	3933	3934	3935
F6x	3936	3937	3938	3939	3940	3941	3942	3943	3944	3945	3946	3947	3948	3949	3950	3951
F7x	3952	3953	3954	3955	3956	3957	3958	3959	3960	3961	3962	3963	3964	3965	3966	3967
F8x	3968	3969	3970	3971	3972	3973	3974	3975	3976	3977	3978	3979	3980	3981	3982	3983
F9x	3984	3985	3986	3987	3988	3989	3990	3991	3992	3993	3994	3995	3996	3997	3998	3999
FAx	4000	4001	4002	4003	4004	4005	4006	4007	4008	4009	4010	4011	4012	4013	4014	4015
FBx	4016	4017	4018	4019	4020	4021	4022	4023	4024	4025	4026	4027	4028	4029	4030	4031
FCx	4032	4033	4034	4035	4036	4037	4038	4039	4040	4041	4042	4043	4044	4045	4046	4047
FDx	4048	4049	4050	4051	4052	4053	4054	4055	4056	4057	4058	4059	4060	4061	4062	4063
FEx	4064	4065	4066	4067	4068	4069	4070	4071	4072	4073	4074	4075	4076	4077	4078	4079
FFx	4080	4081	4082	4083	4084	4085	4086	4087	4088	4089	4090	4091	4092	4093	4094	4095

Figure 66. Hexadecimal/Decimal Conversion Table (Part 4 of 4)

APPENDIX E: NAMES OF PROGRAMS AND MACROS

Relocatable Library Module Name	Core Image Library Phase Name	Program Description	Comments
AORGZ	AORGZ AORGZ2	Reallocate library limits	LORGZ must be on the system pack if this program is to be used.
CORGZ	CORGZ CORGZ1 CORGZ2 CORGZ3	Copy system	
CSERV	CSERV	Core image library service	
DSERV	DSERV	Directory service	
LORGZ	LORGZ	Condense libraries	
MMAINT	MMAINT MMAIN1 MMAIN2	Macro library maintenance	
MSERV	MSERV	Macro library service	
PSERV	PSERV	PUB table service	
RMAINT	RMAINT	Relocatable library maintenance	
RPGAAA	RPG100 RPG102 RPG104 RPG106 RPG108 RPG110 RPG111 RPG112 RPG115 RPG116 RPG118 RPG121 RPG124 RPG127 RPG128 RPG132 RPG135 RPG136 RPG137 RPG138 RPG139 RPG140 RPG141 RPG142	Report Program Generator (part 1 of 3)	

Figure 67. Names of Programs (Part 1 of 4)

Relocatable Library Module Name	Core Image Library Phase Name	Program Description	Comments
RPGBBB	RPG144 RPG147 RPG148 RPG149 RPG150 RPG153 RPG154 RPG155 RPG156 RPG157 RPG158 RPG159 RPG160 RPG161 RPG163 RPG164 RPG169	Report Program Generator (part 2 of 3)	
RPGCCC	RPG171 RPG173 RPG175 RPG176 RPG178 RPG180 RPG181 RPG183 RPG185 RPG187 RPG189 RPG191 RPG193 RPG195 RPG196 RPG198	Report Program Generator (part 3 of 3)	
RSERV	RSERV	Relocatable library service	
SYSCMA**	SYSCMA*	Core image library maintenance	
SYSDMP**	SYSDMP*	Storage dump	Must be cataloged in the core image library of the system pack.
SYSEOJ**	SYSEOJ* SYSBPD*	Job control	Must be cataloged in the core image library of the system pack.
SYSLDR**	SYSLDR* SYSTXT* SYSESD* SYSRLD* SYSXFR* SYSEND* SYSREP* SYSCTL* SYSINC* SYSPH1* SYSPH2* SYSENT* SYSMAP* SYSERR* SYSCMB*	Linkage Editor	Must be available for: link-and-execute compile-and-execute assemble-and-execute SYSCMA program.

Figure 67. Names of Programs (Part 2 of 4)

Relocatable Library Module Name	Core Image Library Phase Name	Program Description	Comments
SYSOA1**	SYSOA1* SYSOA2* SYSOB1* SYSOC1* SYSOC2*	Master open/close	Must be available for: AORGZ, CORGZ, Assembler, or logical IOCS OPEN.
SYSOJ1	SYSOJ1 SYSOJ2 SYSOJ3 SYSOJ4 SYSOJ5	Direct access open/close	Must be available if logical IOCS for direct access files is used.
SYSOLA	SYSOLA SYSOLC SYSOLD SYSOLZ	Indexed sequential open/close	Must be available if logical IOCS for indexed sequential files is used.
SYSOQA**	SYSOQA* SYSOQC* SYSOQD* SYSOQE* SYSOQH* SYSOQI* SYSOQO* SYSOQX*	Consecutive open/close	Must be available for AORGZ, CORGZ, Assembler, or if logical IOCS for consecutive files is used.
SYSOT0	SYSOT0 SYSOT1 SYSOT2 SYSOT3 SYSOT4 SYSOT5 SYSOT6 SYSOT7 SYSOT8 SYSOT9	Tape open/close	Must be available if logical IOCS is used to handle tape files.
SYSRSD	SYSRSD SYSCPD	Disk checkpoint/ restart	Must be available for checkpointing and re- starting programs on a checkpoint area on the system pack.
SYSRST	SYSRST SYSCPT	Tape checkpoint/ restart	Must be available for checkpointing and re- starting programs on tape.
SYSSTA**	SYSSTA* SYSSUP*	System status report Supervisor	Must be available for: AORGZ, Assembler, LOGZ, MMAINT, MSERV, RMAINT, RSERV, SYSCMA, and SYSLDR.

Figure 67. Names of Programs (Part 3 or 4)

Relocatable Library Module Name	Core Image Library Phase Name	Program Description	Comments
ASSEMB	ASSEMB* ZZZ815* ZZZ910* ZZZ920* ZZZ925* ZZZ30A* ZZZ31A* ZZZ32A* ZZZ33A* ZZZ35A* ZZZ39A* ZZZ401* ZZZ403* ZZZ405* ZZZ406* ZZZ408* ZZZ410* ZZZ501*	Assembler (Part 1 of 2)	Both modules must be on the system pack, if programs are to be assembled.
ZZZ56A	ZZZ56A* ZZZ57B* ZZZ57A* ZZZ57C* ZZZ551* ZZZ60A* ZZZ61B* ZZZ62A* ZZZ62B* ZZZ63A* ZZZ65A* ZZZ66A* ZZZ66B* ZZZ67A* ZZZ68A* ZZZ70A* ZZZ71A* ZZZ72A* ZZZ73A* ZZZ75A* ZZZ76A* ZZZ77A* ZZZ772* ZZZ78A* ZZZ80Z*	Assembler (part 2 of 2)	

Note: All items listed in the first column (Relocatable Library Module Name) are contained in the relocatable library of the system pack supplied by IBM.

The module name would be used in the following ways:

1. As the operand of a JOB card when used with EXEC LOADER,R
2. As the operand of a CATAL card (CATAL module-name,R) when cataloging from the relocatable library to the core image library.
3. As the operand of an INCLUDE card when cataloging to the core image library via the INCLUDE function.

* All items in the second column (Core Image Library Phase Name) which are marked with an asterisk (*) are contained in the core image library of the system pack supplied by IBM. All other items are in the relocatable library.

**These items are key system programs which must be edited to run with the new Supervisor when generating a new resident system.

● Figure 67. Names of Programs (Part 4 of 4)

Macro Library Macro Name	Description
DTFSR DTFST DTFSU DTFSV DTFSW DTFSX DTFSY DTFSZ DTFTA DTFTC DTFTE DTFTG DTFTI DTFTK DTFTL DTFTM DTFTO DTFTQ DTFTS DTFTU DTFTW DTFTY DTFUA DTFUD DTFUE DTFUG DTFUI DTFUL DTFUM DTFUO DTFZA DTFZC DTFZE FEOV PRTOV RELSE TRUNC	Consecutive Processing Macros (plus CHNG, CLOSE, CNTRL, DTFBG, DTFEN, GET, LBRET, OPEN, PUT)
DTFDA DTFDC WAITF	Direct Access (DAM) Macros (plus CLOSE, CNTRL, DTFBG, DTFEN, LBRET, OPEN, READ, WRITE)
DTFIA DTFIC DTFIG DTFIH DTFIL DTFIM DTFIQ DTFIR DTFIS ENDFL ESETL SETFL SETL	Indexed Sequential (ISFMS) Macros (plus CLOSE, DTFBG, DTFEN, GET, LBRET, OPEN, PUT, READ, WRITE)

Macro Library Macro Name	Description
CHKPT COMRG DUMP EOJ EXIT FETCH IOCFG JBCTL MSG MVCOM RSTRT SEND STXIT SUPVR SYMUN	System Control Macros
CCB DTFPH EXCP WAIT	Physical I/O Macros (plus CHNG, CLOSE, LBRET, OPEN)
	Common Macros
CHNG	Consecutive Processing and Physical IOCS
CLOSE	Consecutive Processing, Direct Access, and Indexed Sequential
CNTRL	Consecutive Processing and Direct Access
DTFBG	Consecutive Processing, Direct Access, and Indexed Sequential
DTFEN	Consecutive Processing, Direct Access, and Indexed Sequential
GET	Consecutive Processing and Indexed Sequential
LBRET	Consecutive Processing, Direct Access, and Indexed Sequential
OPEN	Consecutive Processing, Direct Access, and Indexed Sequential
PUT	Consecutive Processing and Indexed Sequential
READ	Direct Access and Indexed Sequential
WRITE	Direct Access and Indexed Sequential

Figure 68. Names of Macros

INDEX

- A For Reply Required 26
- ACTION Card 81
- ALLOW WRITE Light 32
- AORGZ Program 50
- Assembler Program 33
 - Assembler-and-Execute 43
 - Control Cards 37-38
 - Device Assignments 34
 - I/O Units Used 35
 - Label Cards Needed 39
 - Operating Considerations 45
 - Output Deck 40
 - Output Listing 41-42
 - Source Deck 36
- Assembling a Program 6
- ASSGN Card 9
 - Format 76
- ATEOF Card 9
- Autotest Program 8

- Backup 72
 - Obtaining 72
 - Recreating with 74
- Binary, Decimal, and Hexadecimal Equivalents 93
- Binary to Decimal Conversion 91
- Binary to Hexadecimal Conversion 92
- BOS Backup
 - Obtaining 72
 - Recreating a System with 74

- Card Formats
 - Job Control 76
 - Linkage Editor Input 81
 - Program Control (Librarian) 85
- Carriage Tape 46
- CATAL Card 85
- Catalog Function
 - Core Image Library 67
 - Macro Library 59
 - Relocatable Library 64
- Checking and Writing Labels 7
- Checkpoint Area
 - On the System Pack 13
- Coded Messages (MSG Macro) 26
- Communication
 - From the System 26
 - To the Problem Program 30
 - To the System 29
- Concepts 5
- Condense Function, LORGZ 58
- Condense Libraries Program 58
- CONDS Card 85
- CONFIG Card 9
 - Format 80
- Console
 - Operator-initiated Message via 30
 - Operator Reply via 28
- Console Information 30
 - Displaying 32
 - Storing 32

- Control Cards
 - Assembler 37-38
 - Job Control 76
 - Librarian (Program Control) 85
 - Linkage Editor 81
- Conversion Tables
 - Binary to Decimal 91
 - Binary to Hexadecimal 92
 - Decimal/Hexadecimal 95
 - EBCDIC 88
- Copy Function, CORGZ 51
- COPYS Card 85
- Copy System Program 51
- Core Image Library 11
- Core Image Library Maintenance Program 67
- Core Image Library Service Program 52
- CORGZ Program 51
- CSERV Program 52

- DATE Card 9
 - Format 79
- Decimal, Hexadecimal, and Binary Equivalents 93
- Decimal/Hexadecimal Conversion 95
- DELET Card 85
- Delete Function
 - Core Image Library 67
 - Macro Library 59
 - Relocatable Library 64
- Device Assignments 10
 - AORGZ 50
 - Assembler 34
 - CORGZ 51
 - CSERV 52
 - DSERV 54
 - LORGZ 58
 - MMAINT 59
 - MSERV 60
 - PSERV 62
 - RMAINT 64
 - RSERV 65
 - SYSCMA 67
 - System Programs 17
- Directory 11
 - Phase 12
 - System 12
 - Transient 12
- Directory Service Program 54
- Displaying Information from Main Storage 32
- DISPLAY Key 32
- Display (Print) Function
 - Core Image Library 52
 - Directory 54
 - Macro Library 60
 - PUB Table 62
 - Relocatable Library 65
- DISPLAY STOR SEL Dial 32
- DLAB Card 9
 - Format 78
- DSERV Program 54
- DSPCH Card 86

DSPLY Card	86	Definition of	11
EBCDIC (Extended Binary Coded Decimal Interchange Code)	88	Directory	11
END Card, Linkage Editor Input	81	Core Image	11
END Card, Program Control	86	Macro	11
ENTRY Card	81	Relocatable	11
Error Codes		Library Programs	46
Byte	32 28	AORGZ	50
Bytes 18-1D	28	CORGZ	51
Byte	32 28	CSERV	52
Bytes 18-1D	28	DSERV	54
Message (MSG) Macro	26	I/O Units Used	46
ESD Card	81	LORGZ	58
EXEC Card	9	MMAINT	59
Format	80	MSERV	54
Extended Binary Coded Decimal Interchange Code	88	Operating Considerations	46
Extent	7	PSERV	62
		RMAINT	64
File Label	7	RSERV	65
FILES Card	9	Status Report	47
Format	77	SYSCMA	67
Formats, Card		Linkage Editor	11
Job Control	76	Input Cards	81
Linkage Editor Input	81	Printed Output	17
Program Control	85	Load System Program	12
Generating a System	68	LOG Card	9
Header Label	7	Format	80
Hexadecimal, Decimal, and Binary Equivalents	91	Operator Instruction	17
Hexadecimal/Decimal Conversion	95	LORGZ Program	58
INCLUDE Card	82	Macro	7
Initial Program Loading (IPL)	8	Macro Definition	7
Input/Output Control System	7	Macro Instruction	7
IOCS	7	Macro Library	11
I/O Device Assignment	10	Macro Library Maintenance Program	59
IPL	8	Macro Library Service Program	60
On the System Pack	12	Macro Names	92
IPL Procedure	15	Main Storage	
JOB Card	9	Displaying Information from	32
Format	76	Storing Information in	32
Job Control	8	Main Storage Address Register	30
Operator Instructions to	17	Main Storage Data Register	30
Job Control Cards	9	Maintenance Programs	
AORGZ	50	MMAINT Program	59
Assembler	34	RMAINT Program	64
CORGZ	51	SYSCMA Program	67
CSERV	52	MAN Light	32
DSERV	54	Messages	26
Format of	76	Replies to	27
LORGZ	58	MMAINT Program	59
MMAINT	59	Module	7
MSERV	60	MSERV Program	60
PSERV	62	NOLOG Card	9
RMAINT	64	Format	80
RSERV	65	Operator Instruction	17
SYSCMA	66	Object Module	7
Label Control Card Area	13	Operating Procedures	15
Labels, Checking and Writing	7	AORGZ Program	50
Librarian	11	Assembler Program	33
Program Control Cards	85	CORGZ Program	51
Library		Creating Backup	72
		CSERV Program	52
		DSERV Program	55
		Generating a System	68
		LORGZ Program	58
		MMAINT Program	59
		MSERV Program	60

PSERV Program	62	Selected Console Information	30
Recreating a System from Backup	74	Sense Information	28
Restarting a Checkpointed Job	25	Service Programs	
RMAINT Program	64	CSERV Program	52
RSERV Program	65	DSERV Program	54
Starting System Operation (IPL)	15	MSERV Program	60
Starting a Job	16	PSERV Program	62
SYSCMA Program	67	RSERV Program	65
Terminating a Job	24	Sort/Merge Programs	7
Operating System, Definition of	5	Source Module	6
Operation of the System	13	Source Program	6
Operator		SPVSR Card	87
Communication	26	Stacked Jobs Example	22
Inquiries	29	Starting a Job	16
Instructions to Job Control	17	Examples	18
Reply to Messages		Starting System Operation	15
Via Console	28	Status Report	47
Via 1052	28	STORE Key	32
PAUSE Card	9	Storing Information in Main Storage	32
Format	8	Supervisor	8
Operator Instruction	17	Communication to	29
Phase	11	Symbolic Units	10
PHASE Card	82	AORGZ	50
Phase Directory	12	Assembler	34
Printer Carriage Tape	46	CORGZ	51
Printer-Keyboard		CSERV	52
Operator-Initiated Messages Via	30	DSERV	54
Operator Reply Via	28	LORGZ	58
Problem Program	6	MMAINT	59
Communication to	29	MSERV	60
Program Control Cards	85	PSERV	62
Program, Definition of	6	RMAINT	64
Program Names	101	RSERV	65
PSERV Program	62	SYSCMA	67
PUB Table Service Program	62	System Programs	17
PUNCH Card	86	SYS000-SYS254	10
Punch Function		SYSCMA Program	67
Core Image Library	52	SYSIPT	10
Macro Library	60	Used by System Programs	17
Relocatable Library	65	SYSLOG	10
Punched Card Output	46	Used by System Programs	17
Reallocate Library Limits Program	50	SYSLST	10
Reallocation Function, AORGZ	50	Used by System Programs	17
Relocatable	11	SYSOPT	10
Relocatable Library	11	SYSRDR	10
Relocatable Library Maintenance		Used by System Programs	17
Program	64	SYSRES	10
Relocatable Library Service Program	65	System Control Panel	31
RENAM Card	87	Operator-Initiated Message Via	29
Rename Function		Operator Reply Via	28
Macro	59	System Control Programs	8
Module	64	System Directory	12
Phase	67	System Disk Pack	5
REP Card	82	Organization of	12
Reply to Messages	26	System Generation	68
Via the 1052 Printer-Keyboard	28	System Operation	13
Via the System Control Panel	28	System/Operator Communication	26
Report Program Generator	7	From the System	26
Residence	5	To the System	29
Restarting a Checkpointed Job	24,10	System Pack Organization	12
RLD Card	83	System Residence Volume	5
RMAINT Program	64	System Status Report	47
RPG	7	Terminating a Job	23
RSERV Program	65	TEST Light	32
RSTRT Card	9	TPLAB Card	9
Format	80	Format	78
		Trailer Label	7

Transient Directory 12
TRCKS Card 87
TXT Card 88

UPSI Card 9
 Format 79
Utility Programs 8

VOL Card 9

 Format 77
Volume Label 7

Writing Labels 7

XFR Card 83
XTENT Card 9
 Format 79

IBM[®]

International Business Machines Corporation

Data Processing Division

112 East Post Road, White Plains, N. Y. 10601

READER'S COMMENT FORM

IBM System/360
Basic Operating System
Control Programs and Assembler
Operating Guide

C24-3450-2

- Your comments, accompanied by answers to the following questions, help us produce better publications for your use. If your answer to a question is "No" or requires qualification, please explain in the space provided below. All comments will be handled on a non-confidential basis. Copies of this and other IBM publications can be obtained through IBM Branch Offices.

- | | Yes | No |
|---|---|--------------------------|
| ● Does this publication meet your needs? | <input type="checkbox"/> | <input type="checkbox"/> |
| ● Did you find the material: | | |
| Easy to read and understand? | <input type="checkbox"/> | <input type="checkbox"/> |
| Organized for convenient use? | <input type="checkbox"/> | <input type="checkbox"/> |
| Complete? | <input type="checkbox"/> | <input type="checkbox"/> |
| Well illustrated? | <input type="checkbox"/> | <input type="checkbox"/> |
| Written for your technical level? | <input type="checkbox"/> | <input type="checkbox"/> |
| ● What is your occupation? _____ | | |
| ● How do you use this publication? | | |
| As an introduction to the subject? <input type="checkbox"/> | As an instructor in a class? <input type="checkbox"/> | |
| For advanced knowledge of the subject? <input type="checkbox"/> | As a student in a class? <input type="checkbox"/> | |
| For information about operating procedures? <input type="checkbox"/> | As a reference manual? <input type="checkbox"/> | |
| Other _____ | | |
| ● Please give specific page and line references with your comments when appropriate. If you wish a reply, be sure to include your name and address. | | |

COMMENTS:

● Thank you for your cooperation. No postage necessary if mailed in the U. S. A.

Fold

Fold

FIRST CLASS
PERMIT NO. 170
ENDICOTT, N. Y.

BUSINESS REPLY MAIL
NO POSTAGE NECESSARY IF MAILED IN THE UNITED STATES



POSTAGE WILL BE PAID BY . . .

IBM Corporation
P. O. Box 6
Endicott, N. Y. 13760

Attention: Programming Publications, Dept. 157

Fold

Fold

Cut Along Line

IBM S/360

Printed in U. S. A.

C24-3450-2



International Business Machines Corporation
Data Processing Division
112 East Post Road, White Plains, N. Y. 10601

Additional Comments: